



PROACTIV[®]



















Usage instructions Service booklet

SPEEDY 4all & 4you
SPEEDY 4all Ergo & 4you Ergo
SPEEDY 4teen

Contents

1	Preface	5
2	Legend.....	5
3	Conformity/other information.....	5
3.1	Classification.....	5
3.2	Conformity.....	5
3.3	Manufacturer.....	5
4	Scope of delivery and testing the product upon receipt	5
5	Introduction.....	6
6	Purpose and indication	6
7	Proper use	7
8	Technical specifications	7
8.1	Product weight	7
8.2	Load weight.....	7
8.3	Obstacle height and turning circle	7
8.4	Basic equipment and dimensions	8
8.5	Service life	8
9	Rating plate & markings on the product	8
10	Commissioning and handover.....	9
11	Introduction to the product & the surroundings	9
12	Safety instructions – prior to driving/use	9
13	Safety instructions – while driving/using	10
14	Safety instructions regarding obstacles	11
15	Safety instructions regarding dangerous locations and dangerous situations	12
16	Safety instructions – after driving/use	12
17	 Individual setting options.....	13
17.1	Adapting the seat height at the back	13
17.1.1	General instructions	14
17.2	Adjusting the seat height at the front / angle of seat	14
17.2.1	Adapting by positioning the caster wheels in the caster fork.....	14
17.2.2	Adaptation by replacing the caster fork	15
17.2.3	General instructions	15
17.3	Adjusting the tipping point.....	16
17.3.1	Inlet types.....	16
17.3.2	Adaptation via horizontal positioning of the wheel plate.....	17
17.3.3	General instructions	18
18	Back system	18

18.1	Backrest angle	18
18.1.1	 Adjustment options with backrests firmly bolted to side sections	18
18.1.2	Adjustment possibilities with an adjustable backrest.....	19
18.1.3	Instructions for sitting posture with an adjustable backrest	19
18.1.4	Adjusting the backrest angle or folding down the backrest with an adjustable backrest.	19
18.2	Adjustable back & its adjustment options	20
18.3	Ergonomic back shell & its setting options	23
18.4	Ergo Back backrest bracket and its adjustment possibilities.....	24
19	Seat system.....	24
20	Clothing guard	25
20.1	Overview of terms.....	25
20.2	Removal and attachment of the clothing guard	27
20.2.1	Removal and attachment of the clothing guard on the SPEEDY 4all, SPEEDY 4you and SPEEDY 4teen models.....	27
20.2.2	Removal and attachment of the clothing guard on the SPEEDY 4all Ergo and SPEEDY 4you Ergo models	28
20.3	 Adjusting the clothing guard position	28
20.4	 Ergo models: adjusting the force required for removing and installing	29
20.5	 Clothing guard size.....	30
21	Drive wheels	31
21.1	Removing and attaching the drive wheels.....	31
21.2	 Checking and adjusting the wheel tracking of the drive wheel	32
21.3	 Wheel camber	33
21.4	Tyre pressure.....	33
21.5	Wheelbase extension	35
21.6	Other	36
22	Caster wheels.....	36
22.1	 Replacing the caster wheels	36
22.1.1	Replacing the caster wheels when mounted using two axle fixing screws	36
22.1.2	Replacing the caster wheels when mounted using an axle fixing screw and nut.....	37
22.2	Caster wheels flapping	38
22.3	Replacing the caster forks	39
22.3.1	 Caster fork with screwed axle	39
22.3.2	Caster forks with quick-release axle	39
22.4	 Adjustment of the caster fork rotary axles.....	40

23 Footrests.....	42
23.1  Angle adjustment of the footplate.....	42
23.2 Continuous footrest and high-distance footrest.....	42
23.3 Footrest folding up to one side	43
23.4 Footrest, fold up to the rear	44
23.5 Footrest, folding up to the rear, with spring latching mechanism	46
23.6 Divided footrest.....	47
23.7 Swing away footrest.....	48
23.8 Safety instructions	49
24 Anti-tipping support.....	49
24.1 Operating and passive position	50
24.2  Removing and attaching the anti-tipping support.....	51
24.3  Height adjustment of the anti-tipping support	52
24.4 Safety instructions	53
25 Brakes	54
25.1 Knee lever brake.....	54
25.1.1 Opening and closing the brake	54
25.1.2  Brake adjustment on the SPEEDY 4all, SPEEDY 4you and SPEEDY 4teen models	55
25.1.3  Brake adjustment on the SPEEDY 4all Ergo and SPEEDY 4you Ergo models ..	56
25.2 Integral parking brake	58
25.2.1 Opening and closing the brake	58
25.2.2  Brake adjustment with standard installation (Ergo models).....	59
25.2.3  Brake adjustment for installation with clamping bracket	60
25.3 Parking knee lever brake for accompanying person	61
25.4 Knee lever brake with lock.....	62
25.5 Drum brake	63
26 Push handles.....	63
26.1 Back tube with integrated handles.....	63
26.2 Aluminium push handles fixed in back tube	64
26.3 Push handles, horizontally screwed in back tube.....	64
26.4 Safety push handles with continuous height adjustment.....	65
26.5 Safety push handles back-positioned	65
26.6 Central push handle with folding gripping area and folding push handle bar.....	66
26.7 Safety instructions	68
27 Passenger transport in motor vehicles.....	68

27.1 Standard specifications.....	68
27.2 Restraint systems	68
27.3 Marking	69
27.4 Fastening the wheelchair in the vehicle.....	69
27.5 Handling instructions and positioning the wheelchair in the vehicle	71
27.6 Safety instructions	73
28 Storage	74
29 Transport	74
29.1 Securing handling of the product.....	74
29.2 Passenger transport in motor vehicles	74
29.3 Securing the product in a vehicle (without a person)	74
29.4 Passenger transport over obstacles in the product.....	74
30 Malfunctions	75
31 Cleaning and care	75
32 Maintenance.....	76
32.1 General instructions.....	76
32.2 Service schedules.....	76
32.3 Proof of maintenance.....	77
33 Disposal & recycling	77
34 Re-use	77
35 Warranty	78
36 Liability.....	78
37 Appendix: Tightening torques, securing details and tools.....	79
38 Appendix: Medical product passport/record of training	80
39 Appendix: Hand-over certificate	81
39.1 Required compliance criteria to authorise use	81
39.2 Check list for training the user	82
40 Appendix: Inspection lists.....	83



The following instructions are intended for and may only be carried out by the rehabilitation specialist dealer or PRO ACTIV.



This document is available in PDF format at www.proactiv-gmbh.com for visually impaired people. Using the zoom function, the font can be increased as desired.

1 Preface

Dear Customer,

Congratulations on purchasing your new PRO ACTIV product. You have bought a quality product which has been specially customised to meet your requirements. We have put together some important instructions about its proper and safe use in the following document. Please read these instructions before using the product.

The standard components are explained in these usage instructions. If you have individual solutions or non-standard components on your product, your rehabilitation specialist dealer or PRO ACTIV would be happy to deal with any questions you may have about using it.

The SPEEDY 4all & 4you, SPEEDY 4all Ergo & 4you Ergo and SPEEDY 4teen products differ with regards to the possibilities for designing the frame geometry individually and the choice of options. If there is a difference in the selection of options, this is mentioned in the respective chapter. Otherwise the operating instructions are identical.

You can always download the latest version of the usage instructions as a PDF document in our download area at www.proactiv-gmbh.com

If you have any further questions about this or any of our other products, we would be glad to be at your disposal.

Enjoy your trips and the best possible mobility.

Your PRO ACTIV team

2 Legend

The symbols used in these usage instructions have the following meanings:



Manufacturer



Note



Serial number

3 Conformity/other information

3.1 Classification

The SPEEDY 4all & 4you, SPEEDY 4all Ergo & 4you Ergo and SPEEDY 4teen rigid frame wheelchairs (called "product" in the following) are classified as class I products.

3.2 Conformity

 As the manufacturer, PRO ACTIV Reha-Technik GmbH declares that the respective product is a class I product and meets the requirements of the EU Medical Devices Directive (2017/745).

If the product is adapted in a manner which has not been agreed by PRO ACTIV Reha-Technik GmbH, this declaration becomes void.

3.3 Manufacturer



PRO ACTIV Reha-Technik GmbH

Im Hofstätt 11

D-72359 Dotternhausen

Phone +49 7427 9480-0

Fax +49 7427 9480-7025

e-mail: info@proactiv-gmbh.de

web: www.proactiv-gmbh.com

4 Scope of delivery and testing the product upon receipt

Delivery includes the product, configured as per the purchase order, with the usage instructions including the training/hand-over certificate and inspection lists. You can view the basic equipment in the "Technical specifications" chapter. As per your order, the product is equipped with additional recommended accessories, such as push handles, anti-tipping supports and a lap belt.

Please check that the delivery is complete after you have received your product.

The product is tested to ensure it is completely functional before shipping and packed in special boxes.

However, please check the product immediately upon receipt, preferably in the presence of the freight company, for any damage which

may have occurred in transit. If you are of the opinion that damage has occurred during transit, please do the following:

1. Record a statement of facts in the presence of the freight company - photo documentation of the packaged product and the unpacked product with detailed images of product damage
2. Preparation of a declaration of assignment - you assign all claims from this damage to the freight company.
3. Statement of facts/photo documentation, delivery note, and declaration of assignment are sent to PRO ACTIV.

Failing to observe these instructions, or reporting damage after acceptance, means that the damage cannot be acknowledged.

PRO ACTIV will subsequently review the damage and discuss the further procedure with you (shipment of replacement parts, returning the product to PRO ACTIV for a complete repair, etc.).

5 Introduction

Before starting your first journey, familiarise yourself with these usage instructions, paying particular attention to all of the safety information and hazard warnings contained in them.

Allow your therapists and doctors to advise you as well as your carers and assistants on how to use the product and what you are permitted to do with the product based on your current ability. Clarify with them as well which wheelchair techniques you can learn on the basis of your ability.

 Under no circumstances should you do anything with or in the product that you have not learned to do and have not mastered.

You, your carers, and assistants should also seek advice from your therapists and doctors as well as the rehabilitation specialist dealer about the use and settings of your product as well as the safety accessories available (e.g. anti-tipping supports and lap belt).

 You should always heed the advice provided by doctors, therapists and the rehabilitation specialist dealer on the necessary safety accessories.

 If you are not sure how to handle the product or if technical faults occur, please contact your rehabilitation specialist dealer or PRO ACTIV before using it.

 Never leave the product unattended.

 Secure the product against unauthorised use and theft.

 When combining your product with equipment made by other manufacturers (e.g. seat cushions, drive devices, etc.), make sure that the suitability of the individual components and the unit made up of them is ensured. Information on the suitability of the combination can be obtained from the manufacturer of the third-party components or from your rehabilitation specialist retailer.

 The product contains small parts that may pose a choking hazard for children.

6 Purpose and indication

This product offers persons who have difficulty walking or cannot walk the option of replacing walking with driving using a muscle-powered wheelchair to a technically feasible extent. The objective is to maintain or increase the greatest possible independent mobility and to integrate the active wheelchair user in everyday life.

Indications: Walking impediment or limited ability to walk due to paralysis, limb loss, limb defect/deformation, joint contractions/joint damage, neurological and muscular diseases.

Contraindications: Some wheelchair options are unsuitable for certain disease profiles or handicaps. A suitable selection will be made by the therapist/doctor/rehabilitation specialist dealer during the consultation.

In addition - for safety reasons - the product may only be operated by people who

- can move and coordinate their hands and arms so that they are able to operate all control elements without restrictions while using the wheelchair.
- are physically and mentally capable and have the visual ability to safely operate the product in all operating situations and can meet the legal requirements for use on public roads. For children or people with mental, significant motor or visual impairments, the attendants can ensure the required traffic safety as a substitute and as a companion.
- have been trained in its use by the rehabilitation specialist dealer or PRO ACTIV.

7 Proper use

This wheelchair is designed for use on level and solid surfaces indoors and outdoors. Avoid driving on unpaved or loose surfaces (e.g. on loose gravel, in sand, mud, snow, ice or through deep puddles of water, and under poor weather conditions (e.g. storms), as this may result in incalculable risks.

The maximum permitted load of the product in its standard design is 120 kg. The heavy-duty version and individual customisations can be designed for a higher load; this is then indicated on the rating plate. Please note that the load limit indicated on the rating plate may not be exceeded even when transporting objects and carrying out strength exercises in the product. Note that the maximum load weight is reduced accordingly due to mounting components with low load limits on the product, e.g. drive wheels with few spokes.

Proper use of the product is a basic requirement of safe operation. The product may generally be used only for applications that are listed and described in these usage instructions. This includes storage, transport, maintenance/inspection, and repair, as well as the safety information in each chapter of these usage instructions.

Supplement for SPEEDY 4teen: Besides a variety of adjustment options, the SPEEDY 4teen adolescent's wheelchair can grow with the user by exchanging individual components, therefore offering optimum adaptation to the user's individual needs and size.

The maximum permitted load of the product in its standard design is 100 kg. Individual customisations can be designed for a higher load; this is then indicated on the rating plate.

8 Technical specifications

8.1 Product weight

The total weight starts from 9.2 kg with the basic equipment.

8.2 Load weight

Maximum load weight, SPEEDY 4all, 4you, 4all Ergo, 4you Ergo:

Up to 120 kg payload

Maximum load weight, SPEEDY 4teen:

Up to 100 kg payload

The heavy-duty version and individual customisations can be designed for a higher load; this is then indicated on the rating plate.

8.3 Obstacle height and turning circle

Maximum traversable/negotiable obstacle height: 10 cm

Turning circle:

- approx. 1.3 m without manoeuvring back and forth
- approx. 1.1 m with manoeuvring back and forth (strongly dependent on the number of manoeuvres)

8.4 Basic equipment and dimensions

In the basic equipment, the product is equipped with seat and back system, side sections, caster wheels, drive wheels including tyres and handdrims, knee lever brake and foot-rest.

Dimensions, Speedy 4all:

Seat width: 30 - 52 cm | Seat depth: 36 - 48 cm
 Back height: 20-48 cm
 Wheel camber: 1°, 4°, 6°
 Back angle: Seat tube / back tube opening angle 70°-95°

Dimensions, SPEEDY 4you:

Seat width: 30 - 52 cm | Seat depth: 36 - 54 cm
 Back height: 23-48 cm
 Wheel camber: 1°, 4°, 6°
 Back angle: Seat tube / back tube opening angle 70°-95°

Dimensions, SPEEDY 4all Ergo:

Seat width: 30 - 52 cm | Seat depth: 36 - 48 cm
 Back height: 20-48 cm
 Wheel camber: 1°, 4°, 6°
 Back angle: Seat tube / back tube opening angle 70°-95°

Dimensions, SPEEDY 4you Ergo:

Seat width: 30 - 52 cm | Seat depth: 36 - 54 cm
 Back height: 23-48 cm
 Wheel camber: 1°, 4°, 6°
 Back angle: Seat tube / back tube opening angle 70°-95°

Dimensions, SPEEDY 4teen:

Seat width: 26 - 43 cm | Seat depth: 32 - 48 cm
 Back height: 20-48 cm
 Wheel camber: 1°, 4°, 6°, 8°
 Back angle: Seat tube / back tube opening angle 70°-95°

Active growth with SPEEDY 4teen:

The SPEEDY 4teen's seat width can be increased to adapt to the adolescent's growing body dimensions. To widen the product, the two cross-connection tubes and the back cross bar can be telescoped in 1-cm steps according to the holes. From an original seat width of 26 cm, this adjustment range is 4 cm. A new

cross tube set, which is also available in 1-cm steps, can be used to widen the product further. When equipped with an adjustable back and seat upholstery with belt system, widening up to 20% of the original seat width is possible. This is not possible when equipped with the Body Contour seat upholstery. Before all widening measures, a check must be performed to determine whether exchanging components is necessary. Contact your rehabilitation specialist dealer or PRO ACTIV if you want to change the seat width.

8.5 Service life

The service life of the product is 6 years.

9 Rating plate & markings on the product

The **rating plate** is located on the product frame. The rating plate includes the precise model, the serial number and other technical specifications.

When contacting your rehabilitation specialist dealer or PRO ACTIV with regard to your product, please always have the serial number and year of construction on the rating plate at hand.



 CE marking
 "European conformity"

 Medical device

 Manufacturer

 Follow the usage instructions

 Serial number

 Date of manufacture

The product is labelled with **further symbols** (stickers):



Product not approved as a seat in motor vehicles



Product approved as a seat in motor vehicles; marking of the transport restraint system connections on the wheelchair or fastening points for wheelchair restraint systems

More detailed information about this can be found in Chapter 27.

10 Commissioning and handover

The product will be handed over to you ready for use by a rehabilitation specialist dealer or a field representative or by a product consultant from PRO ACTIV.

You will be fully instructed in the use of the product based on the usage instructions included in delivery. You will be handed over a training certificate and handover certificate as written proof. In addition, you will be given the usage instructions and, if necessary, further accessories for your own use. It is recommended that you take along an assistant for the training so that, if required, they can assist you later when handling the product.

During the hand-over, the training certificate (Chapter 38) and the hand-over certificate including the associated check list (Chapter 39) must be filled in. The rehabilitation specialist dealer should send the completed documents to PRO ACTIV for filing as a file by e-mail or in the form of a copy by fax or in the post.

11 Introduction to the product & the surroundings

During the initial commissioning of the product, drive at minimum speed and become accustomed to the driving characteristics of the product. Always adapt the speed and driving

manoeuvres to match your own abilities and external circumstances. You will get a feel for how to use the product safely after a short time. Before driving up or down slopes or hills with the product, you should be proficient in the safe handling of the product on level ground.

Practice bending over, gripping, stretching and getting out, until you know the limits of your abilities. Allow yourself to be assisted until you know what can cause falls or tips and how to avoid it.

Get to know the environment in which you want to use the product. Look out for obstacles and learn how to overcome or avoid them.

12 Safety instructions – prior to driving/use

 When getting into the wheelchair, do not tread on the footrests as this may tip the chair over.

 Before every trip, check the condition of the wheels (e.g. visual inspection of the spokes and rims, check the tyres for damage, foreign bodies and crack formation). If you have any doubts about the serviceability of the product, stop using it.

 Check the tyre pressures at regular intervals. Ensure that you comply with the manufacturer's specifications that can be found on the tyres. If the tyre pressure is too low, the optimum functional capability of the knee lever brake is not guaranteed, and an excessively low tyre pressure influences the driving behaviour. Apart from that, there is an increased risk of a flat tyre.

 Before starting out, check that the product's brake works. If all existing brakes are not fully functional, no trips may be taken.

 Check the stable condition of the seat and backrest upholstery at regular intervals and in case of doubt, have your rehabilitation specialist dealer assess its condition.

 Always ensure that your feet cannot slip off the footplate support when using the product.

 Before using the product, ensure that the anti-tipping supports are in the operating position and are functional.

 Due to environmental effects, it is possible that the properties and therefore secure attachment of the push handle covers may change detrimentally. For this reason, it is important to check that the handles are tightly fitted and fixed in position prior to use. If this should no longer be the case, then the push handles may not be used until they have been fixed.

 Before each use of the product, make sure that the anti-tipping supports and push handles are firmly attached and the quick-release axles on the caster and drive wheels are also securely locked in place.

 Depending on equipment, the product may have folding/closing mechanisms that pose a risk of crushing injuries (e.g. trapping your fingers). Therefore, have your rehabilitation specialist dealer explain how these mechanisms work and test them yourself under supervision.

 If required, you can have your product equipped with a suitable chest or lap belt. Make sure that the belt is worn so that it does not negatively affect your breathing, cannot strangle you if you fall or tip out of the product and so that you can easily remove it yourself.

 Make sure that the passive illumination (reflectors) are always on your product, are in perfect condition and are clearly visible.

 When travelling, always carry a repair kit and tyre pump for repairs in event of punctured/flat tyre. An alternative to this is a pump spray that fills your tyre with a foam that hardens in the tyre.

13 Safety instructions – while driving/using

 Note that some parts of your product can become extremely hot at high ambient temperatures (e.g. sauna). This means that above 50°C, the product may be damaged and above 40°C there is already the risk of burns for the user, which should not be underestimated, particularly for people with impaired sensitivity. For this reason, the product should not be exposed to such extreme temperatures. PRO ACTIV cannot accept any liability or provide any warranty for personal injury and material damage caused by such stresses. There are also certain risks that exist at extremely low temperatures, which must be minimised e.g. by wearing appropriate insulating clothes.

 You may only drive on slopes where the product can be safely controlled with the handrims. Never drive the product on slopes of more than 10 %.

 When driving in curves, reduce your speed to a minimum and if possible, lean your upper body towards the curve.

 Do not ride parallel to slopes and inclinations due to the risk of tipping.

 Do not stop on a steep slope, otherwise there is a risk of losing control of the product. If possible, do not turn on a slope or change your direction.

 Note that the knee lever brake and the integrated brake are parking brakes that may only be applied when the product is at a standstill. These are not service brakes that are suitable for reducing speed.

 Do not attach objects (carrier bags, etc.) to the product.

 When driving in areas that are approved for pedestrians, keep to the maximum permitted speed (walking speed 6 kph) and adhere to a sufficient lateral distance (at least the width of a wheelchair) from obstacles and other road users.

 Avoid driving on unpaved or loose surfaces (e.g. on loose gravel, in sand, mud, snow, ice or through deep puddles of water).

 When travelling on poorly maintained paths (e.g. large gravel, potholes), there is an increased risk of puncturing your tyres as well as tipping.

 When travelling on poorly maintained paths with potholes and loose stones, drive carefully to prevent the caster wheels from blocking.

 The product can affect other devices, for example theft protection barriers in department stores.

 The product is only intended for transporting one person with limited mobility and must not be used for any other purpose, e.g. for transporting goods.

 When reversing, the anti-tipping supports should always be used as there is an increased risk of tipping over. If this is not possible, then ask other people to help ensure that there is no risk of tipping over.

 The product may only be propelled using the handrims. If you propel the chair with the tyres (thumbs or fingers on the tread of the tyre), there is the risk of crushing or otherwise injuring fingers and thumbs.

 Do not reach into the area of the spokes or other tight spaces in the area of the wheels. There is an increased risk of being injured here, particularly while in motion. If you have limited coordination of your limbs, then you should protect the spokes with e.g. a spoke shield to minimise the risks.

 Smoking when using the wheelchair should be forgone, as the seat and back system may be damaged due to dropping ash.

14 Safety instructions regarding obstacles

 Driving on steps with the product is forbidden.

 Due to the significantly high risk of tipping over and being injured, the product should only be driven on an escalator after participation in a corresponding safety training course and with an accompanying person for safety reasons.

 The maximum obstacle height that can be negotiated is 10 cm.

 Obstacles like curbs, for example, should always be negotiated driving forwards and always using the minimum speed required.

 When driving over or passing obstacles, it is important that you avoid any product or body parts catching on the obstacle as this may lead to falls causing serious injuries to the user and third parties as well as damage to the product.

 Always drive over curbs or other obstacles so that you cross them to the front or at right angles. When approaching an obstacle at an angle or driving over it with just one drive wheel, there is an increased risk of tipping over sideways.

 If the product with the user needs to be transported over an obstacle and there are suitable facilities such as a ramp or a lift available, then these should be used. If such facilities are not available, then the obstacle is to be overcome by carrying with two helpers. When carrying the product, it may not be lifted by the side sections, the drive wheels or the footrests. We recommend holding the product on the frame and the back cross bar to carry it.

 Before crossing an obstacle (steps, thresholds, etc.), the anti-tipping supports must be swivelled from the operating to the passive position so that you do not make contact with the obstacle when crossing, resulting in your falling. After crossing the obstacle, the anti-

tipping supports must be immediately returned to the operating position (Chapter 24).

 For overcoming obstacles such as kerbs or steps, the product needs to be actively tipped. The caster wheel may otherwise jam at right angles to the obstacle and could block. This could damage the caster wheel or the caster fork and result in injury to the user. If actively tipping it is not possible, then the obstacle should not be approached or you need to request assistance from an accompanying person. Particular attention needs to be paid to this when using an auxiliary drive.

15 Safety instructions regarding dangerous locations and dangerous situations

The operator of the product determines the route to be driven themselves, taking the usage instructions, their driving knowledge, and physical abilities into consideration.

The personal driving skills are particularly important in the following dangerous locations that are provided as examples; the product's user must use their judgement before driving in such locations:

- quay walls, landing and berthing locations, paths and locations close to water, unsecured bridges and dykes.
- narrow paths, slopes (e.g. ramps and driveways), narrow paths on a slope, mountainous routes.
- narrow and/or steeply sloping paths along main roads or near cliffs.
- routes that are covered in leaves, snow or ice.
- ramps and lifting equipment on vehicles.

 When driving in a curve or turning on hills or downward slopes, there may be an increased tendency to tip over to the side due to the changes in the centre of gravity. Avoid such driving manoeuvres. If these cannot be

avoided, perform these driving manoeuvres with increased caution and only at a very slow speed. If necessary, the driving manoeuvre must not be performed or only with the help of an assistant.

 Use particular caution when approaching stairs, edges, drops or other hazard areas.

 Extreme caution is needed when crossing main roads, intersections and level crossings. Rails in the road or level crossings must never be crossed when travelling parallel to them, as otherwise the wheels could become caught which would result in the product being unable to manoeuvre.

 Extreme caution is needed when driving on ramps and lifting equipment on vehicles. Ensure in advance that the ramp is wide enough so that you do not risk the product wheels slipping off the ramp. When lifting or lowering a ramp or lifting equipment, the parking brake of the product should be applied. Always keep the product in the middle of the ramp.

 The grip of the tyres on the ground is reduced under wet conditions. There is an increased risk of slipping. Adjust your driving, braking and steering behaviour accordingly.

16 Safety instructions – after driving/use

 Apply the parking brake before getting out of the product.

 When getting out of the wheelchair, do not tread on the footrest due to the risk of tipping over.

17 Individual setting options

 The following instructions are intended for and may only be carried out by a rehabilitation specialist dealer or PROACTIV

17.1 Adapting the seat height at the back

The product is equipped with a wheel plate that permits seat height adjustment in steps of 1 cm.

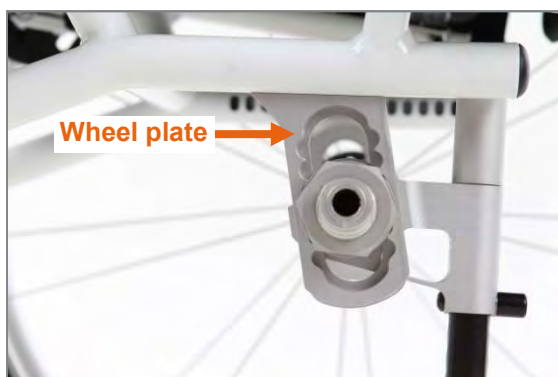

Figure 1: Wheel plate for rear seat height adjustment (view from outer side of product, drive wheel removed)

To adjust the seat height, first remove the drive wheels using the quick-release axles (see Chapter 21.1) and turn the product over so that you have direct access to the wheel plates. Then proceed as follows:

1. Open the aluminium locking nuts (AF 41 mm) on both sides and keep turning them out on the drive wheel bushings until the position gate positioned underneath it can be pushed out of the wheel plates onto the drive wheel bushings.



Figure 2: Aluminium locking nuts and drive wheel bushing (view from outer side of product)



Figure 3: Position gate (view from outer side of product)



Figure 4: Different position gates depending on the equipment of the product and user weight



Figure 5: Aluminium locking nut released and position gate pushed towards aluminium locking nut (view from outer side of product)

2. Position the axle tube at the desired and equal height on both sides and fix the axle tube in this position by pushing the position gates on the right and left sides to the corresponding height position of the wheel plates.

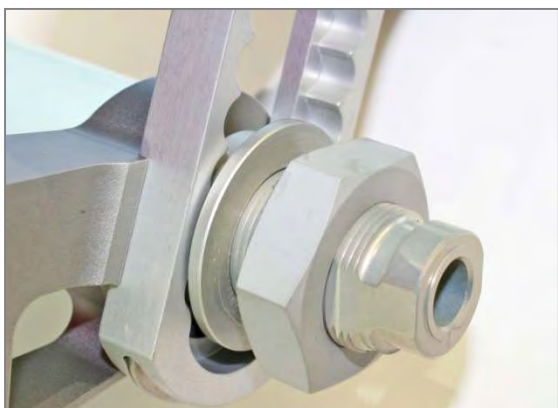

Figure 6: Axle tube fixed in position with position gate (view from outer side of product)

3. Position the aluminium locking nuts back on the drive wheel bushings so that they rest slightly against the position gates, and then set the drive wheel track correctly (see Chapter 21.2).

17.1.1 General instructions

When changing the rear seat height each time:

- the wheel track of the drive wheels must be checked and readjusted if necessary (see Chapter 21.2).
- the brakes must be readjusted (see Chapter 25).
- the caster wheel axles must be readjusted (see Chapter 22.4).
- the backrest angle may have to be repositioned (see Chapter 18.1).
- make sure that there is sufficient clearance under the footrest. Experience shows that this should not be less than 4 cm (see Chapter 23).
- if necessary, the height of the anti-tipping support may have to be readjusted (see Chapter 24.3).

17.2 Adjusting the seat height at the front / angle of seat

If the seat height has to be adjusted, the angle of the seat or the front seat height can be adjusted. This setting is carried out via the position of the caster wheels in the caster wheel fork and the caster fork size.

17.2.1 Adapting by positioning the caster wheels in the caster fork

Adjusting the front seat height or angle of seat can be carried out via the positioning of the caster wheel in the caster fork. Generally, the caster forks have three possible positions that can be used to change the front seat height in steps of 15 mm.

- If the seat inclination or the front seat height are to be increased, the caster wheel is mounted in a lower position in the caster fork.
- If the seat inclination or the front seat height are to be reduced, the caster wheel is mounted in a higher position in the caster fork.

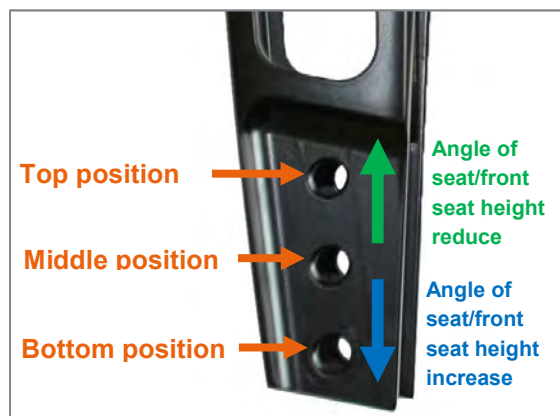

Figure 7: Three positions in the caster fork for positioning the caster wheel and its effect on the front seat height

The instructions for disassembly and assembly of the caster wheels can be found in Chapter 22.1.

17.2.2 Adaptation by replacing the caster fork

If the adjustment range of the existing caster fork is insufficient, the next larger or smaller one can be used.

In doing so, the bottom position of the fork size 1 is equivalent to the top position of fork size 2 and the bottom position of fork size 2 to the top position of fork size 3.



Figure 8: Caster fork sizes with marking of the same seat height settings with different caster fork sizes

The instructions for replacing the caster forks can be found in Chapter 22.3.

17.2.3 General instructions

When changing the angle of seat or front seat height each time:

- the wheel track of the drive wheels must be checked and readjusted if necessary (see Chapter 21.2).
- the caster wheel axles must be readjusted (see Chapter 22.4).
- the backrest angle may have to be repositioned (see Chapter 18.1).
- make sure that there is sufficient clearance under the footrest. Experience shows that this should not be less than 4 cm (see Chapter 23).
- if necessary, the height of the anti-tipping support may have to be readjusted (see Chapter 24.3).

17.3 Adjusting the tipping point

Optimum product tipping behaviour is achieved when the axle mount of the drive wheels is close to the body centre of gravity. A product adjusted like this can be driven with little effort and it also makes it possible to manage a slightly uneven surface or edges by tipping slightly. Driving on both drive wheels (doing a wheelie) is relatively easy to learn. Inexperienced wheelchair users must be prevented from tipping over backwards by means of anti-tipping supports.

To ensure safe operation, the **tipping point setting** should always be selected to suit the wheelchair user's individual requirements and abilities.

17.3.1 Inlet types

The tipping point is set by changing the horizontal position of the wheel plate on the frame.

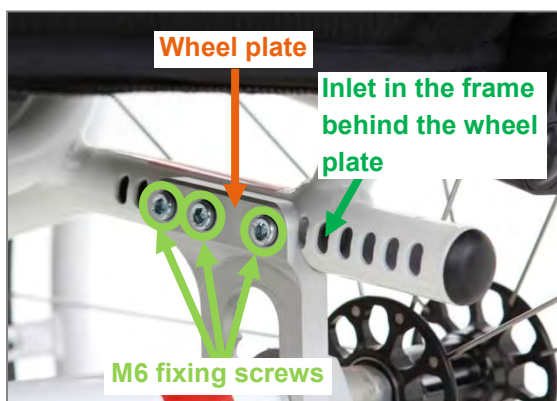

Figure 9: Inlet and wheel plate (view from inner side of product)

The wheel plate is mounted on the lower frame tube using three M6 fixing screws and one inlet in the frame. With the inlets, differentiate between the long and short inlets. The selection of the inlet is orientated, e.g. to the seat width, the weight of the wheelchair user, the type of wheel plate or the equipment (e.g. one-hand operation, wheelbase extension). Depending on the inlet length, then the procedure for adapting the tipping point also differentiates.

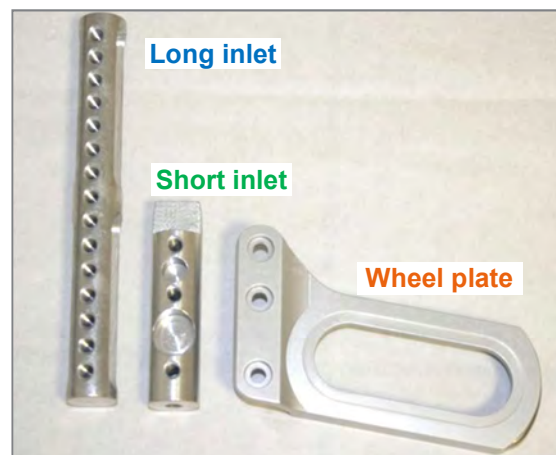

Figure 10: Long and short inlet with wheel plate

As an assembly aid, the short inlet has a thread in the end face and the long inlet does not.

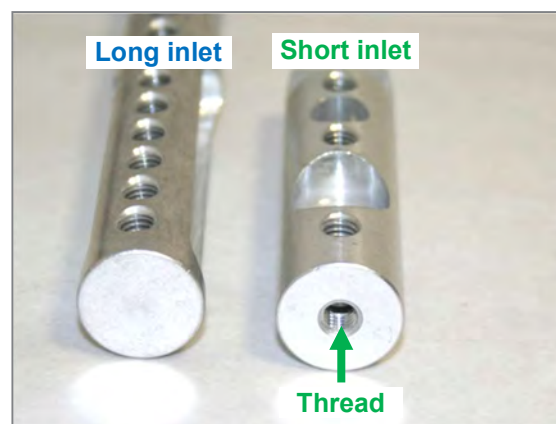

Figure 11: Long inlet without and short inlet with thread in the end face

The following features indicate if a long or a short inlet is installed: With the short inlet, a tube plug is applied to the end of the frame, the long inlet does not have one.

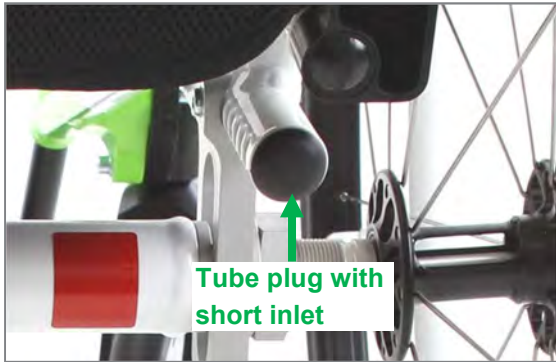

Figure 12: Tube plug at the end of the frame means "short inlet" (view from the rear)

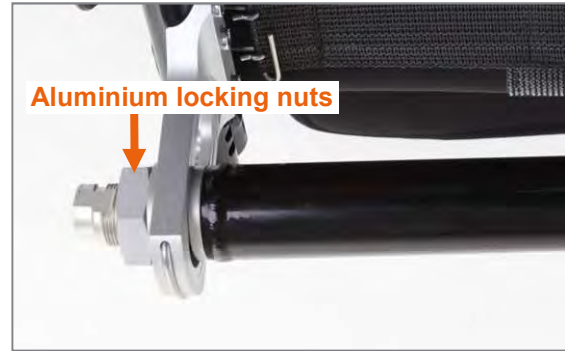

Figure 14: Aluminium locking nut (view from below)

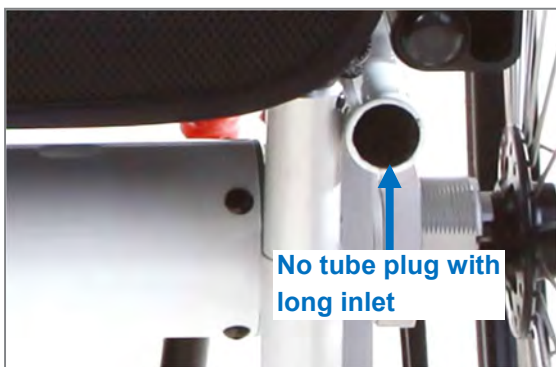

Figure 13: No tube plug at the end of the frame means "long inlet" (view from the rear)

17.3.2 Adaptation via horizontal positioning of the wheel plate

In order to adjust the tipping position, first remove the drive wheels via the quick release axles (see Chapter 21.1) and turn the product around so that you have direct access to the wheel plates. Then proceed as follows:

1. Slightly undo the aluminium locking nuts on both sides.

2. This step affects the fixing of the inlets:

If you have long inlets in the frame, on each side turn one M6 screw into a tipping position not required during the adjustment in order to fix the inlets during the adjustment process. These inlets must not be moved during the adjustment as they cover all tipping points due to their length. However, the screws prevent the inlets from twisting and thus, the thread of the inlets and the tipping point position of the frame are no longer resting precisely on top of one-another.

If you have short inlets in the frame, remove the tube plugs on both sides and turn the long M6 screws into the thread of the inlet in the frame from behind in order to fix the inlet and to be able to move it into position afterwards during the adjustment. These inlets must be moved into position during the adjustment as they must be positioned directly behind the wheel plates due to their length.

Note:

The tube plugs are inserted very tight and must be removed using a screwdriver or a knife.



Figure 15: Short inlet with M6 screw screwed in (outside the frame for better illustration)

- Remove the three fixing screws (AF 5 mm) on both wheel plates.



Figure 16: M6 fixing screws (view from bottom and inner side of product)

- Now set the wheel plates at the desired tipping position on both sides of the frame. Take care that the wheel plates on the right and left sides are installed at the same tipping point position.

If you have short inlets in the frame, using the long M6 screws that you have previously screwed into the thread from behind, you have to position this accurately behind the wheel plates so that the tipping point positions in the frame and thread rest accurately against one another in the frame and thread.

The long inlets do not have to be moved.

- Then fix both wheel plates again, each with three M6 fixing screws and tighten these slightly (2 Nm).
- With long inlets in the frame, now you can remove the additional fixing screws again (see step 2).

If you have short inlets in the frame, now you can remove the long M6 screws from the threads of the inlets and reinsert the tube plugs at the ends of the frame.

- Position the aluminium locking nuts back on the drive wheel bushings so that they rest slightly against the position gates and then set the drive wheel track correctly (see Chapter 21.2).
- Then tighten the three M6 fixing screws on each of the wheel plates to 10 Nm.

17.3.3 General instructions

After each change to the tipping point:

- the wheel track of the drive wheels must be checked and readjusted if necessary (see Chapter 21.2).
- the caster wheel axles must be readjusted (see Chapter 22.4).
- the brakes must be readjusted (see Chapter 25).

Extreme settings such as drive wheels mounted far to the front are only permitted for experienced wheelchair users who are able to actively shift their weight forwards during operation.

To minimise the risk of tipping backwards, we recommend using anti-tipping supports, even with anti-tipping settings.

18 Back system

Avoid falling into the seating and backrest upholstery/back shell as it significantly increases the risk of an adjustment, falling down or defects.

18.1 Backrest angle

18.1.1 Adjustment options with backrests firmly bolted to side sections

The following instructions are intended for and may only be carried out by a rehabilitation specialist dealer or PROACTIV

With backrests bolted firmly to the side sections, there are no options for flexible backrest angle adjustment without tools.

However, permanent adjustment of the backrest 5° forwards or backwards is possible using tools. To do this, there are three holes in the rear area of the side section at the top and an elongated hole at the bottom to position the backrest tubes. To adjust the backrest 5° for-

wards or backwards, loosen both M5 fixing screws (AF 3 mm) with washers on each side and position the fixing screws with washers in the desired holes of the side section at the top and bottom in the corresponding position in the elongated hole (same position on the right and left). Then tighten up the M5 fixing screws (AF 3 mm) again to 6 Nm and secure these with thread lock fluid.



Figure 17: Adjusting the backrest position using holes in the side section

18.1.2 Adjustment possibilities with an adjustable backrest

If equipped with an adjustable and foldable backrest, the backrest angle can be flexibly adjusted without using tools and the backrest can be completely folded away. The angle of the backrest can be fixed in 7 positions in 5° steps.

 Observe that the centre of gravity is shifted further to the rear by the enlargement of the angle between the backrest and the seat system and thus, the tipping point of the product is reached much sooner.

18.1.3 Instructions for sitting posture with an adjustable backrest

For a good sitting posture, we recommend positioning the backrest vertical to the ground, where possible.

With low backrests with adaptable belt cover due to a disability, it may be advantageous to slightly tilt the backrest forwards and to slacken the top belt of the backrest upholstery so that the slack in the upper area is greater in order

to achieve good sitting stability under certain circumstances (see Chapter 18.2).

The adjustment possibility of the backrest angle supports active sitting and ensures for flexibility of the wheelchair user. An example in the following:

- if the angle of the seat has been changed (see Chapter 17.2), the angle of the backrest can be respectively readjusted.
- When driving on slopes and when transporting baggage (e.g. backpacks) on the backrest, the centre of gravity shifts more to the rear and the risk of tipping increases. Then this can be counteracted by a respective angle adjustment of the backrest to the front.
- For comfortable seating, the backrest can be locked in a position to the rear so that the backrest is tilted slightly back.

18.1.4 Adjusting the backrest angle or folding down the backrest with an adjustable backrest

To **adjust the backrest angle**, relieve it (otherwise there is a risk of tipping) and then loosen the locking pins that engage in the locking holes of the side sections on the left and right. For this purpose, grasp under the seat upholstery and in the middle, pull the cord to the front that is linked to the locking pin.



Figure 18: Locking pin connected to a cord (view from inner side of product)

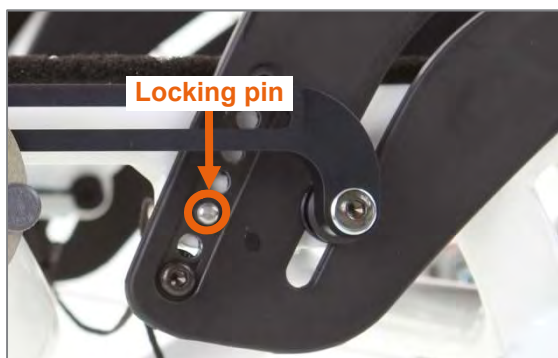

Figure 19: Locking pin engages in the locking hole in the side section (view from outer side of product, without clothing guard)

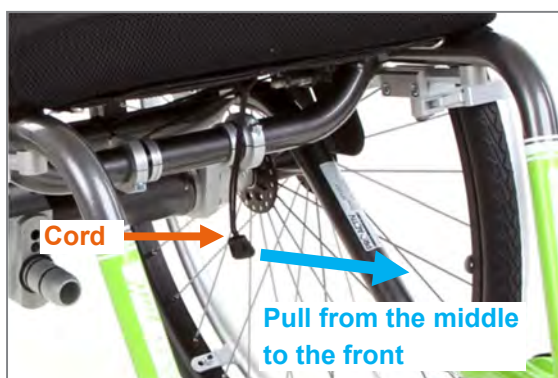



Figure 20: Cord for operating the locking pin and thus for adjusting the angle of the backrest

If you have released both locking pins by pulling on the cord, you can adjust the backrest as desired and re-engage it by letting go of the cord. In doing so, before applying load again, make sure that both locking pins have engaged safely into the desired locking holes (the same position on the right and left).

A stop pin may be mounted in the backrest angle **adjustment range** as a limiter.



Figure 21: Stop pin (view from outer side of product)

 Depending on the adjustment of the backrest angle, check the tight engagement of the backrest via the locking pins.

To **fold down the backrest**, pull on the middle of the cord towards the front, and at the same time, fold the backrest downwards until it rests on the seating area. If you want to return the backrest to the desired angle, proceed as described at the beginning of backrest angle adjustment.



Video Adjustment of the backrest angle & folding

18.2 Adjustable back & its adjustment options

The "adjustable back and back padding" back system consists of a belt system and back padding. The slack of the backrest can be adapted to the individual requirements via the belts with tensioning loops.

First remove the back padding that has been covered over which has been attached using hook-and-loop straps. The belt system located underneath has been set in the factory that the top and the bottom belts have a slack of approx. 2 cm. The middle belts have been pulled tight for a good lumbar support.

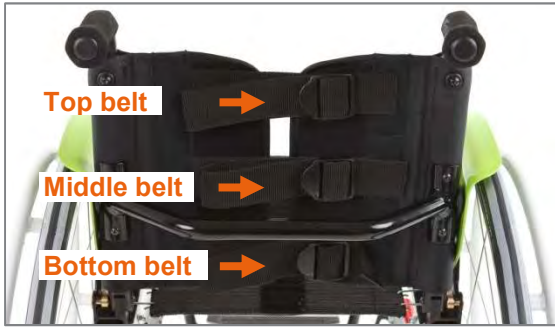

Figure 22: Belt system of the adaptable backrest upholstery with three belts

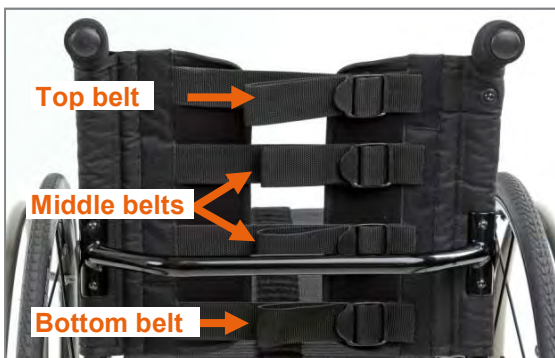

Figure 23: Belt system of the adaptable backrest upholstery with four belts

To **adjust the slack in the belt system**, the tensioning loop of the respective belt is held by its strap and pressed to the right until the belt slackens.



Figure 24: Push the tensioning loop onto its strap on the right



Figure 25: Tensioning loop open completely

Now the belt can be pulled tight for setting a small slack or loosened for a large slack (Fig. 26 and 27). The belt does not have to be threaded out of the tensioning loops for this.



Figure 26: Reduce the slack



Figure 27: Increase the slack

In order to put the tensioning loops back onto the back system loosely again, pull the loop section at the back to the left. You should dose your pulling force with care in order not to adjust the set slack again.



Figure 28: Then re-apply the tensioning loops back on the back system



Figure 31: Step 2: Threading in the belt



Figure 29: Tensioning loops applied slightly to the back system



Figure 32: Step 3: Pulling the belt through

Then re-mount the back padding using the fleece hook-and-loop straps.

If the belt should have mistakenly been threaded out during the adjustment, see the following figures for **threading the belt in correctly**:



Figure 33: Step 4: Simple threading in of the belt through the tensioning loops



Figure 30: Step 1: Threading in the belt

 The belts must always be threaded through the tensioning loops twice as otherwise, the belts will slacken when using the product and with intensive loading, the middle web of the tensioning loops will bend through intensively.



Figure 34: Step 5: Returning the belt through the tensioning loop to obtain the required "double passage"



Figure 35: Step 6: Pulling the belt through for the double passage



Figure 36: Step 7: Double passage



Figure 37: Step 8: Threading in the belt



Figure 38: Step 9: The belt has been fully threaded

18.3 Ergonomic back shell & its setting options

The "ergonomic back shell" back system consists of an aluminium shell, Velcro cross-straps and back padding.

Slack is already integrated into the back shell due to its shape. It cannot be adjusted.

However, **lumbar support** can be adjusted individually using the Velcro cross-straps. For this purpose, the back padding is removed over the Velcro straps. The cross-straps can now be tensioned according to the individual requirements by releasing and refastening the Velcro strap system.



Figure 39: Ergonomic back shell (view from behind)

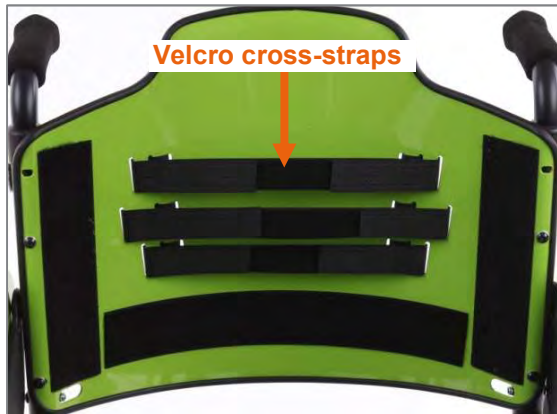

Figure 40: Ergonomic back shell without back padding with Velcro cross-straps (view from the front)

Then mount the back padding using the Velcro straps.

18.4 Ergo Back backrest bracket and its adjustment possibilities

The back system "Ergo Back backrest bracket" normally consists of a backrest bracket (with or without lumbar curvature) and an adjustable backrest upholstery including customised back padding. The adjustment possibilities of the **adjustable backrest upholstery** are described in Chapter 18.2.



Figure 41: Ergo Back backrest bracket with adjustable backrest upholstery, back padding attached (view from the rear)



Figure 42: Ergo Back backrest bracket with adjustable backrest upholstery with four belts, back padding removed (viewed from the rear)

If the Ergo Back backrest bracket is fitted with a **back shell** instead of the adjustable backrest upholstery, the adjustment possibilities described in Chapter 18.3 apply.



Figure 43: Ergo Back backrest bracket with back shell (viewed from the rear)

19 Seat system

 Avoid falling into the seating and backrest upholstery/back shell as it significantly increases the risk of an adjustment, falling down or defects.

The seat system usually consists of either sprung Body Contour seat upholstery or a belt system. The SPEEDY 4teen is additionally equipped with the aluminium seat plate.

With a seating system from **Body Contour seat upholstery**, there is no adjustment option. The Body Contour seat upholstery has a springing effect and when seating., automatically forms a slack.



Figure 44: Body Contour seat upholstery

The **belt system** can be subsequently adjusted. Using the fleece hook-and-loop straps, the slack in the seating surface can be changed so that it suits your seat cushion system. In doing so, the seat tension should not have too much slack to avoid touching the frame cross tubes.



Figure 45: Open belt system with fleece hook-and-loop straps for adjusting the slack

The **aluminium seat plate** offers no adjustment options. It is often used as the base for designing individual, anatomically shaped seat systems.



Figure 46: Aluminium seat plate

Note:

Using a seat cushion on the seat system is mandatory. At cold temperatures, the seat cushion prevents lower abdomens from under-cooling and protects against dirt and wetness. Moreover, the cushion ensures uniform pressure distribution for your bottom and absorbs impacts as well as vibrations.

20 Clothing guard

20.1 Overview of terms

In the following, you can see an overview of terms for all models **SPEEDY 4all**, **SPEEDY 4you** and **SPEEDY 4teen**.



Figure 47: Back jointed shaft



Figure 48: Clothing guard removed from product



Figure 49: Clothing guard mounted on product (view without drive wheel)

The following shows an overview of the terms used for the **SPEEDY 4all Ergo** and **SPEEDY 4you Ergo** models.



Figure 52: Back jointed shaft

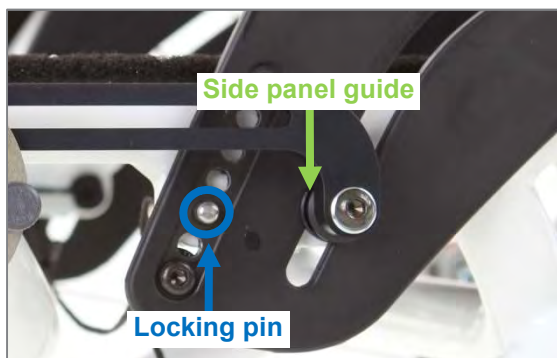

Figure 50: Locking pin engages in the locking hole in the side section (view without clothing guard)

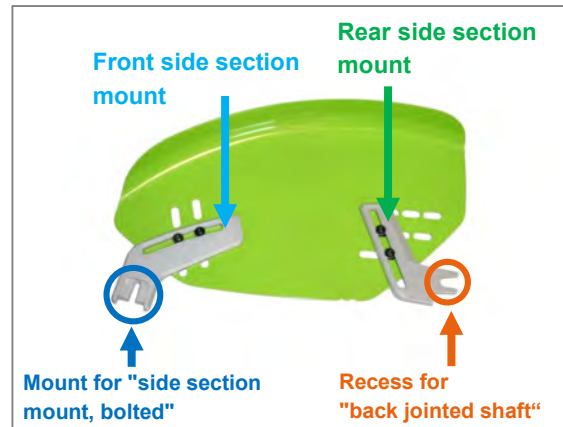

Figure 53: Clothing guard removed from product

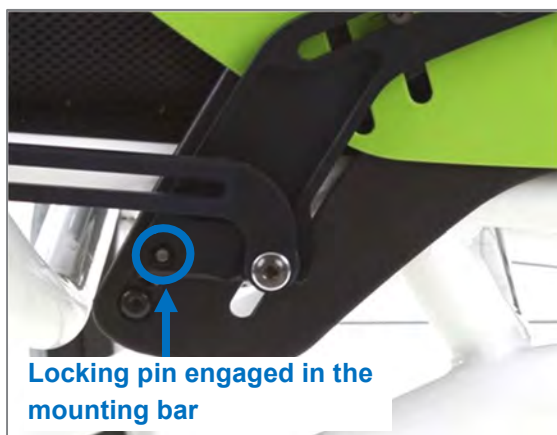

Figure 51: Locking pin engaged in the mounting bar of the clothing guard (view with clothing guard)



Figure 54: Clothing guard mounted on product (view without drive wheel)



Figure 55: "Side section mount, bolted" (view without clothing guard)

20.2 Removal and attachment of the clothing guard

20.2.1 Removal and attachment of the clothing guard on the SPEEDY 4all, SPEEDY 4you and SPEEDY 4teen models

The locking pins must first be released to **remove the clothing guard**. For this purpose, grasp under the seat upholstery and in the middle, pull the cord to the front that is linked to the locking pin and keep it in this position.



Figure 56: Locking pin connected to a cord (view from inner side of product)

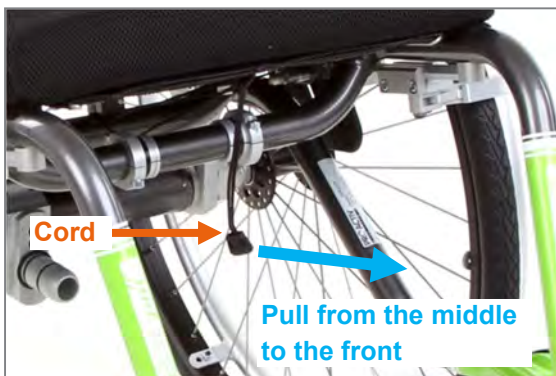

Figure 57: Cord for actuating the locking pins

⚠ Observe: In case you are sitting in the product when removing the clothing guard, you have to relieve the backrest before pulling the cord.

Now, first the clothing guard can be removed from the side panel guide for the mounting bar (then the cord can be released again) and pulled from behind the back joint shaft.



Figure 58: Clothing guard pulled from the side panel guide to the front (shown without drive wheel)

To **mount the clothing guard**, this is first connected to the rear of the back joint shaft with the mounting bar, then the mounting bar is inserted at the front in the side panel guide and pressed downwards until the locking pin engages in the mounting bar.



Figure 59: Mounting bar pinned on the back jointed shaft (shown without drive wheel)

20.2.2 Removal and attachment of the clothing guard on the SPEEDY 4all Ergo and SPEEDY 4you Ergo models

To **remove the clothing guard**, it is first pulled from the "side section mount, bolted" at the front and then from the back joint shaft at the rear.



Figure 60: Clothing guard pulled from the "side section mount, bolted" at the front (view without drive wheel)

To **attach the clothing guard**, this is first mounted on the back joint shaft with the rear side section mount and then the front side section mount is inserted in the "side section mount, bolted".



Figure 61: Rear side section mount mounted on back joint shaft (view without drive wheel)

20.3 Adjusting the clothing guard position

 The following instructions are intended for and may only be carried out by a rehabilitation specialist dealer or PROACTIV

After adjusting the drive wheel position or installing different tyres on the drive wheels, it may be necessary to adjust the position of the clothing guard on the wheel arch. The distance between the tyres and the clothing guard should be between 5 and 8 mm to avoid pinching your fingers, scraping the tyres on the clothing guard, and obstruction when grasping the handrim.

To adjust the clothing guard position, loosen the two or four M5 fixing screws (AF 3 mm) from the clothing guard mounts on each of the clothing guards.



Figure 62: Clothing guard mount



Figure 63: M5 fixing screws and elongated holes of the mounting bar (SPEEDY 4all, -4you and -4teen)



Figure 64: M5 fixing screws and elongated holes of the side section mounts (SPEEDY 4all Ergo and -4you Ergo)

Now the mounting bar (with SPEEDY 4all, -4you and -4teen) or the front and rear side section mounts (with SPEEDY 4all Ergo and -4you Ergo) can be moved into position along the elongated holes of the clothing guard and the mounting bar or the side section mounts. On the Ergo models, it must be ensured that the side section mounts can be smoothly inserted back onto the back joint shaft and into the side section mount.

Finally the clothing guard mounts are positioned accordingly and the M5 fixing screws (AF 3 mm) are screwed back into the clothing guard mounts with 6 Nm.



Figure 65: Slots of the clothing guard

20.4 Ergo models: adjusting the force required for removing and installing

 The following instructions are intended for and may only be carried out by a rehabilitation specialist dealer or PROACTIV

To make the removal and installation of the clothing guard easier or more difficult, adjustments can be made on the "bolted side section mount". In doing so, there are three options for adjusting the intensity of the pulling or pressing

force required for removing and installing the clothing guard.

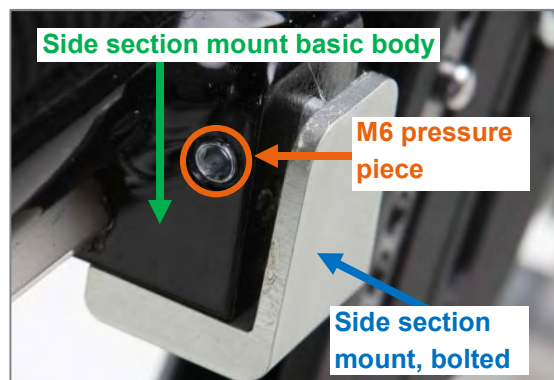

Figure 66: M6 pressure piece screwed into "basic body of side section mount"

If the front side section mount has too much or too little play in the "side section mount, bolted", it can be adjusted using the **M6 pressure piece** in the basic body of the side section mount. To reduce the play in the front side section mount, screw the M6 pressure piece (AF 3 mm) in a little more by turning to the right. To increase the play, turn anti-clockwise to unscrew the M6 pressure piece (AF 3 mm) slightly.



Figure 67: Back side of the sprung pressure piece with slot



Figure 68: Front side of the sprung pressure piece with ball

If the effort required for removing or installing the clothing guard is still too easy or difficult after carrying out the previous adjustment, another setting can be carried out via the spring suspended pressure pieces. Screw in the **"M6 sprung pressure pieces"** (AF 3 mm) a little more (clockwise) using a slotted screwdriver (on the back side of the basic body of the side section mount) (Fig. 69) so that they protrude further out of the basic body of the side section mount (Fig. 70) to increase the force required when removing and installing.

To reduce the force required when removing and installing, screw out the "M6 sprung pressure pieces" a little more (anti-clockwise) so that they protrude a little less out of the basic body of the side section mount.

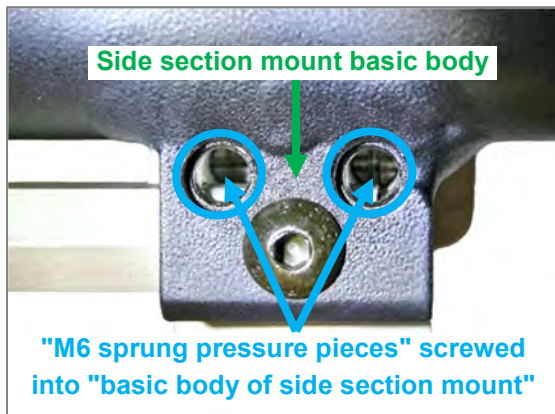

Figure 69: "M6 sprung pressure pieces" screwed into "basic body of side section mount" (view from inner side of product)

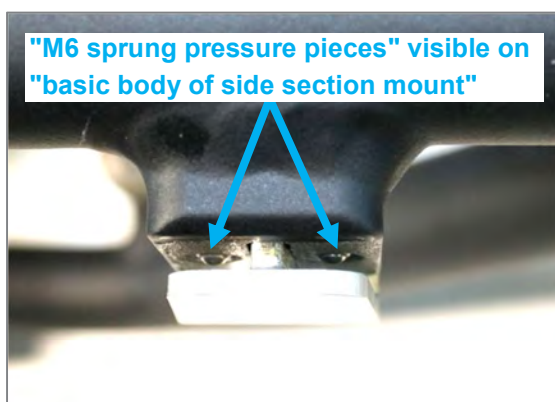

Figure 70: Front side of the sprung pressure pieces visible (view from top)

As a final option for adjusting the force required when removing and installing the clothing guard, slightly release the **M5 fixing screws** (AF 4 mm) and pull the "side section mount, bolted" along its slots a little further away from the basic body of the side section mount or press it a little closer towards the basic body of the side section mount.



Figure 71: "Side section mount, bolted" with elongated holes and M5 fixing screws on basic body of side section mount (view from below)

20.5 Clothing guard size

The following instructions are intended for and may only be carried out by a rehabilitation specialist dealer or PROACTIV

The clothing guard (aluminium and carbon) is available in three different sizes. The dimensions of the wheel arches differentiate with the different sizes:

30 mm (size 1), 36 mm (size 2),
46 mm (size 3).

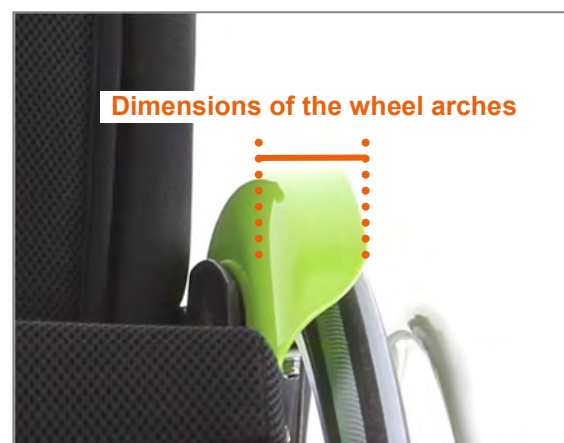

Figure 72: Dimensions of the wheel arches

The size of the clothing guard can be read-off the notches on the bottom edge of the clothing guard. One notch means size 1, two notches mean size 2 and three notches mean size 3.



Figure 73: Size marking on the clothing guard

After changing to a wider tyre size or after changing the wheel camber, it may be necessary to change to another clothing guard size. Where required, such a change may be arranged by your rehabilitation specialist dealer.

21 Drive wheels

21.1 Removing and attaching the drive wheels

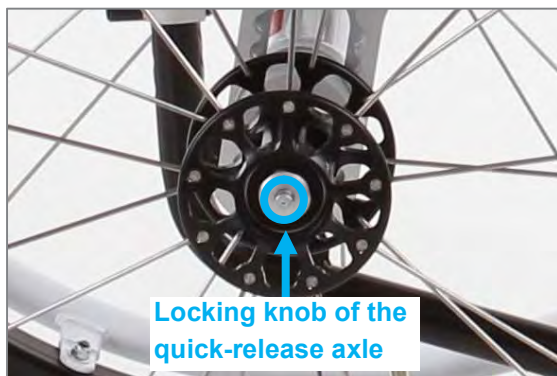

Figure 74: Locking knob of the quick-release axle in the middle of the wheel axle

To **remove the drive wheels** grip through the spokes around the wheel hub with your fingers. The wheels can be unlocked and removed by pressing and holding the locking knob at the centre of the wheel axle with your thumb.

When **attaching the drive wheels**, the locking knobs must be pressed and the drive wheels

with quick-release axle must be inserted in the drive wheel bushings. When doing this, special attention should be paid to ensure that the locking knob springs out again after attaching the wheel, as otherwise the wheels are not properly secured. You will know this if you can see the index groove.

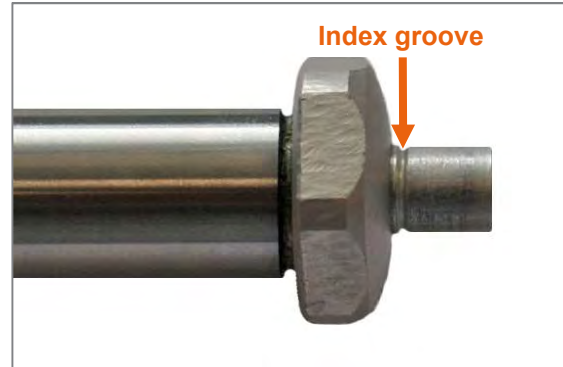

Figure 75: Quick release axle with index groove

The quick-release axle is equipped with the small standard locking knobs (see previous figure) as standard. The **quick-release axle with operation support and large push button** can be equipped as an option. The sequence for removing and attaching the drive wheels is identical with this option.



Figure 76: Quick-release axle with operation support, large push button

! Before using the product, check if the wheels are secured and that the quick release axles are locked.

Recommended equipment:

For quadriplegics or people with limited finger function, a **Tetra Clip** is available to operate the quick-release axle lock. The Tetra Clip is a plastic housing that is screwed onto the outer side of the drive wheel hub and operated by means of a push-through pin. The pin has a red marking on one side (quick release axle

opened) and a green marking on the other side (quick release axle locked). The pin can be pushed using the ball of your hand in the direction of the middle of the drive wheel and thereby the quick release axle opened or closed.

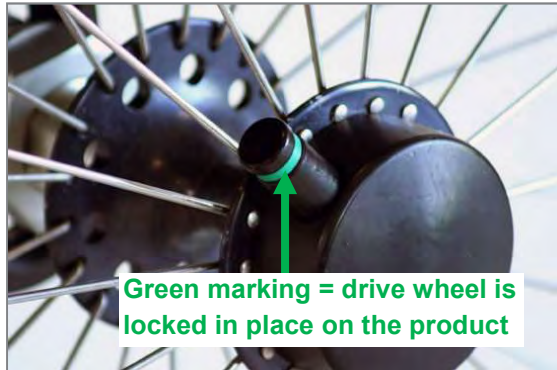



Figure 77: Tetra Clip with locked quick release axle



Figure 78: Tetra Clip with opened quick release axle, drive wheel can be removed

21.2 Checking and adjusting the wheel tracking of the drive wheel

 The following instructions are intended for and may only be carried out by a rehabilitation specialist dealer or PROACTIV

Well adjusted wheel tracking significantly improves the easy running characteristics of the product. To **check** the tracking, proceed as follows:

Position the product on a level surface and secure the product against rolling away.

Measure the axle heights (from the ground to the drive wheel axle) and write this dimension onto both tyres at front and back.



Figure 79: Drawing the axle height on the front and back of both tyres

Afterwards measure the distance between the drive wheels front and back at the height of the axles along the markers. Ideally, the distance between the two drive wheels should be the same size at the front and back. In general it can be said that the distance between the drive wheels at the front may not be larger than at the back. Apart from that, the distance at the back may not be more than 5 mm larger than at the front. If this is not the case, the wheel tracking needs to be corrected.

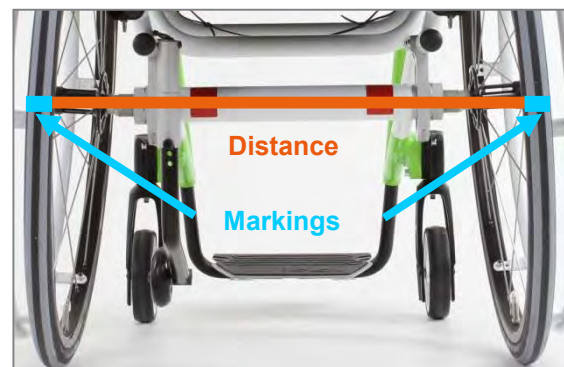

Figure 80: Distance between the markers on the tyres (at axle height), back

To **adjust the track** proceed as follows:

1. Loosen the aluminium locking nuts on both sides (AF 41 mm).

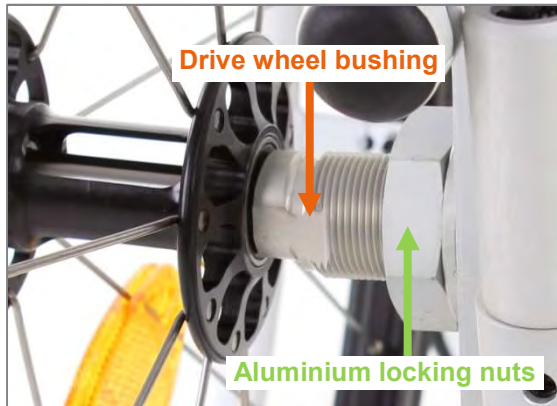

Figure 81: Drive wheel bushing and aluminium locking nut (rear view)

2. Correctly adjust the track by turning the drive wheel bushing (AF 22 mm). Here it can be said that: If you turn the drive wheel bushing in the direction of travel, the track at the front will become more narrow. The exact opposite occurs if you turn it counter to the direction of travel; the track becomes wider.
3. Make sure that the distance at the front to the frame on the right and left is the same.

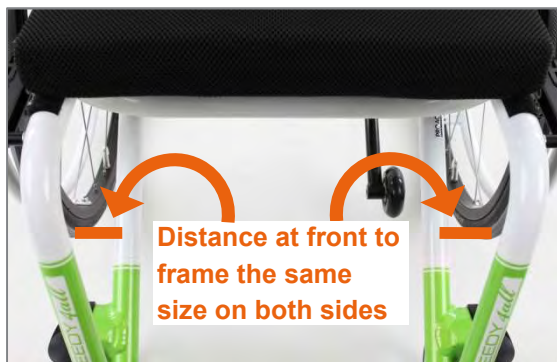

Figure 82: Distance at the front to the frame

4. Measure the distance between the drive wheels at the front and back again at the axle height (along the markers) so that the distance between the drive wheels is not any larger at the front than at the back. Apart from that, the distance at the back

may not be more than 5 mm larger than at the front.

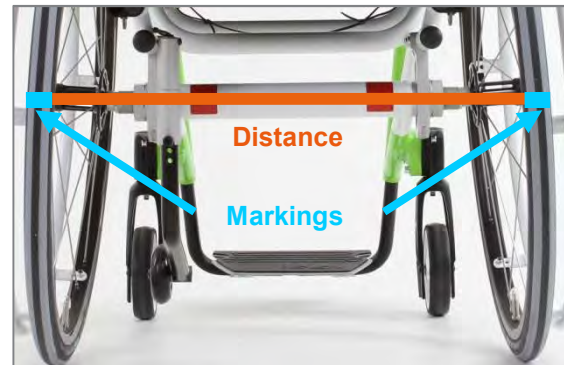



Figure 83: Distance between the markers on the tyres (at axle height), back

5. Once all of the distances are correct, use an open-ended spanner (AF 22 mm) to hold the drive wheel bushing in position and tighten the aluminium locking nuts (AF 41 mm) to a tightening torque of 70 Nm.

21.3 Wheel camber

 The following instructions are intended for and may only be carried out by a rehabilitation specialist dealer or PROACTIV

The wheel camber increases the lateral stability of the product but also increases the overall width of the product.

The wheel camber will be carried out according to the order and can be subsequently changed by replacing the drive wheel bushings (with integrated wheel camber). If you would like to change the camber, contact your rehabilitation specialist dealer or PROACTIV.

21.4 Tyre pressure

Check the tyre inflation pressure at regular intervals as well as after extreme influence of temperature (not on solid rubber tyres). The **maximum and if applicable, minimum tyre pressure is printed on the side of the tyre.** This should be observed.

 If the tyre pressure is too low, the optimum functional capability of the knee lever brake and the integral brake is not guaranteed, and an excessively low tyre pressure influences the driving behaviour negatively. Apart from that, there is an increased risk of a flat tyre.

 The tyre pressure increases with the temperature. If the pressure is too high, the tyre may burst. For this reason, product tyres may not be exposed to unusually high temperatures such as in a sauna or under glass in the summer.

 When inflating the tyres, make sure that the prescribed air pressure is not exceeded.

To check or correct the tyre pressure, proceed as follows:

1. Secure the product to prevent it rolling away.
2. The drive wheel is normally fitted with a car tyre valve. Unscrew the valve cap.

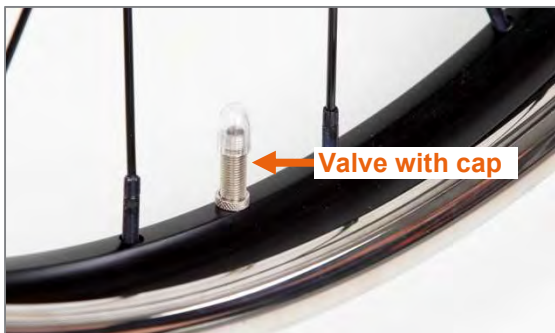

Figure 84: Valve with cap

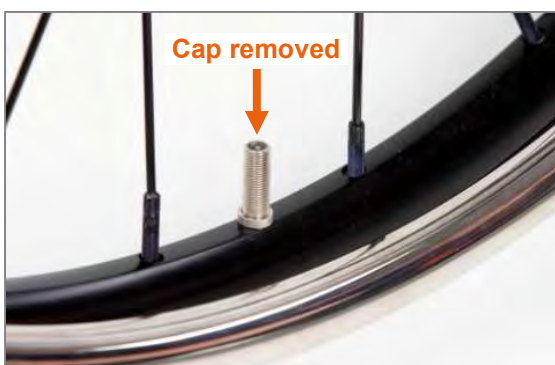

Figure 85: Valve without cap

3. Place the valve attachment of the compressed air device or the compressor onto the valve (if necessary, an adapter must be placed on the valve attachment) and, if a clamp lever is fitted, secure the connection by applying the lever.
4. Now check the tyre pressure. If the tyre pressure does not match the specifications, correct it.
5. Finally release the clamp lever (if present), pull the valve attachment off the valve and replace the valve cap.



Figure 86: Compressor

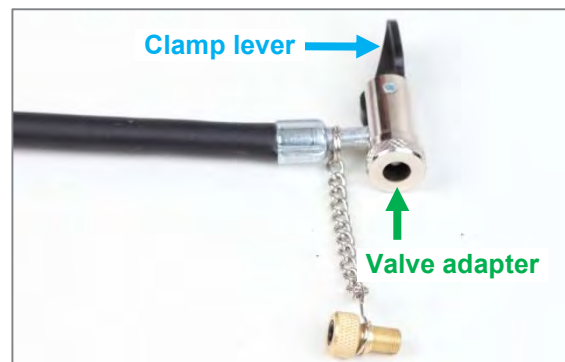

Figure 87: Valve adapter and clamp lever of the compressor

21.5 Wheelbase extension

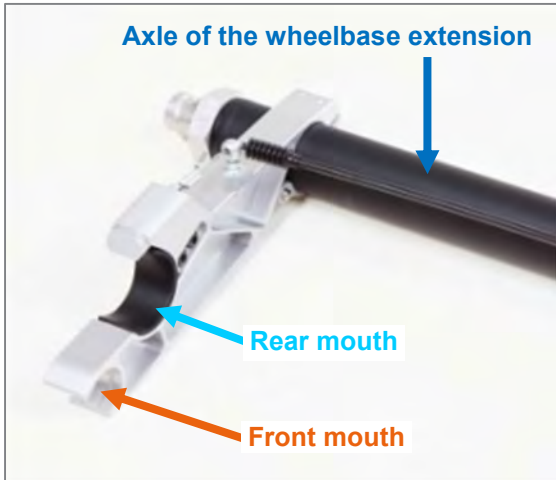

Figure 88: Designation overview with wheelbase extension

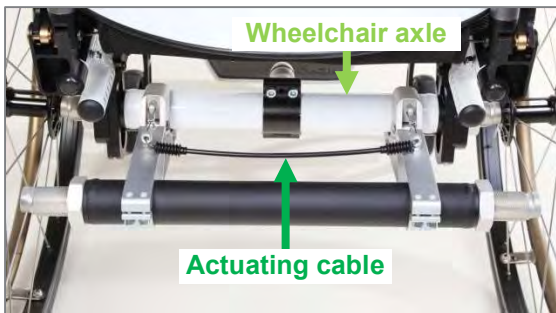

Figure 89: Designation overview with wheelbase extension and wheelchair

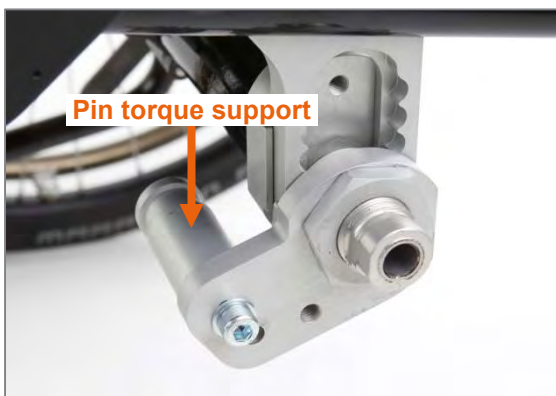

Figure 90: Torque support pin mounted on the product (view from outer side of product without drive wheel)

To **attach the wheelbase extension**, pull the actuating cable and hold it in this position. Guide the front mouth underneath the wheelchair axle and insert this on both sides on the "Pin torque support". Now lift the wheelbase extension until the rear mouth surrounds both sides of the wheelchair axle. The actuating cable can then be released. Now the wheelbase extension is fixed tight.



Figure 91: Wheelbase extension attached (view from outer side of product without drive wheel)



Figure 92: Wheelbase extension attached (view from behind)

To **remove the wheelbase extension**, pull the actuating cable and hold it in this position. Release the rear mouth from the wheelchair axle on both sides by moving the wheelbase extension down slightly. Then pull the front mouth from the "Pin torque support" on both sides. The actuating cable can now be released.



Video Removing & attaching the wheelbase extension

For **changing the drive wheels** between the wheelchair axle and the axle of the wheelbase extension, proceed as described Chapter 21.1.



Video Changing the wheel in the wheelbase extension

21.6 Other

If tyres, inner tubes or handrims need to be replaced, please contact your rehabilitation specialist retailer.

Recommended equipment:

The spoke guard prevents hands and fingers entering and being trapped in the wheels when riding. The risk of injury is thus minimised.



Figure 93: Spoke guard for minimising the risk of hands and fingers getting trapped

22 Caster wheels

22.1 Replacing the caster wheels



The following instructions are intended for and may only be carried out by a rehabilitation specialist dealer or PROACTIV

The caster wheels of the product are, depending on the type of casters, either fastened with two M6 axle fixing screws or one M6 axle fixing screw and a M6 nut.

22.1.1 Replacing the caster wheels when mounted using two axle fixing screws

To **remove a caster wheel**, unscrew the M6 axle fixing screws (AF 4 mm) on one side.



Figure 94: M6 axle fixing screw of caster wheel axle (view from outer side of product)



Figure 95: Caster wheel with aluminium hexagon socket

Now you can see the aluminium axle with a hexagon socket (AF 4 mm) in the middle of the axle. This hexagon socket is used to fix the axle in place, while the second M6 axle fixing screw (AF 4 mm) is unscrewed. To do this, insert an Allen key (AF 4 mm) into the hexagon socket on the aluminium axle and hold it still. At the same time, unscrew the remaining M6 axle fixing screw (AF 4 mm) on the other side.

Now the caster wheel can be removed from the fork. One spacer each is mounted to the right and left on the caster wheel that you are able to remove in order for it to be reused later when reinstalling the new caster wheel. If you want to install a different type of caster wheel, use the enclosed spacers, as these generally differ depending on the type of caster wheel.



Figure 96: Spacer on the caster wheel

To **mount the caster wheel**, proceed in the reverse order as for removal. Please make sure that the spacers on the right and left on the caster wheel are re-installed in the caster fork before assembly. The torque of the M6 axle fixing screws (AF 4 mm) is 7 Nm. It is recommended only to use screws with polymer dry locking coating. Screws without polymer dry locking coating must be secured with screw locking fluid.

22.1.2 Replacing the caster wheels when mounted using an axle fixing screw and nut

To **remove the caster wheel**, hold the M6 nut (AF 10 mm) firmly and loosen the M6 axle fixing screw (AF 4 mm). Now you can remove the M6 nut and washer, the M6 axle fixing screw with washer and the caster wheel.

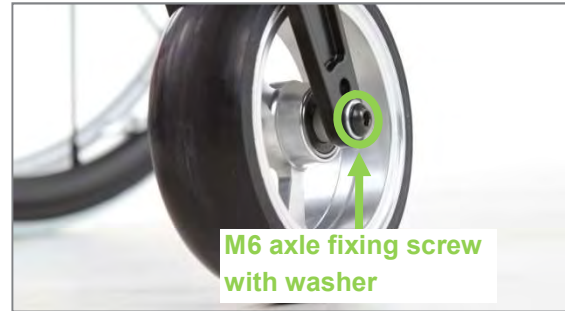

Figure 97: M6 axle fixing screw of caster wheel axle (view from outer side of product)



Figure 98: M6 caster wheel axle nut (view from inner side of product)



Figure 99: Caster wheel with aluminium axle



Figure 100: Spacer on the caster wheel

When **mounting the caster wheel**, position the caster wheel with its spacers in the caster wheel fork, hold it in position and insert the M6 axle fixing screw with its washer from the outside of the product to the inside through the axle of the caster wheel. Now attach the washer and the M6 nut (AF 10 mm) from the other side. The tightening torque of the axle fixing screws (AF 4 mm) is 7 Nm.

22.2 Caster wheels flapping

Uncontrolled swivelling backwards and forwards of the caster wheels around their axes on the caster fork (while moving) is known as "fluttering".

 If the caster wheels start to flutter, immediately reduce your speed to prevent the caster wheels from jamming sideways and therefore reduce your risk of falling.

The **speed limit** where caster wheel fluttering starts, **is reduced by**:

- increasing size of the caster wheels
- increase weight of the caster wheels
- falling load on the caster wheels
- decreasing caster length of caster wheels

The following options are available to **counteract caster wheel fluttering in general**:

- Fluttering can be reduced by **reducing the caster wheel diameter**. This means installing a small caster wheel in a different wheel position in the caster fork (seat height thus remains the same) would be one way of reducing fluttering. However, please note that using a smaller caster wheel makes it more difficult to overcome obstacles and makes tipping necessary more often. The smaller the caster wheel is, the more driving skill is required.
- Another option for reducing fluttering is to use a **lighter caster wheel with the same diameter** or, as described above, **with a smaller diameter**.



Figure 101: Caster length

- It is also possible to **increase the caster length**. The caster length is the distance between the rotary axle of the caster fork projected onto the floor and the wheel contact point. The wheel contact point of the caster wheel trails behind the rotary axle as it were. The caster length has a stabilizing effect on moving in a straight line. Increasing the caster length can be attained by mounting the caster wheel in a different wheel position on the caster fork (the in doing so, the front seat height or the angle of the seat changes, see Chapter 17.2). Another possibility is to bend the caster wheel axle (see Chapter 22.4) forwards in the direction of travel in the lower area. The angle of the caster wheel axle can be adjusted up to approximately 4 mm over the length of the caster wheel bearing block out of the vertical. This increases the caster length and the tendency to vibrate reduces.

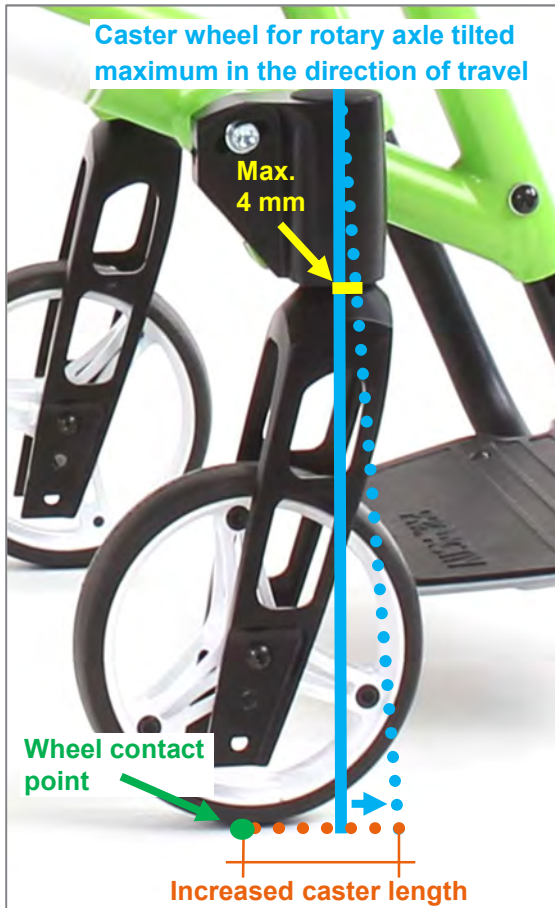



Figure 102: Increased caster length via the inclination of the caster wheel axle

22.3 Replacing the caster forks

A distinction needs to be made between the caster forks with a screwed axle and those with a quick-release axle.

22.3.1 Caster fork with screwed axle

 The following instructions are intended for and may only be carried out by a rehabilitation specialist dealer or PROACTIV

To **remove the caster fork with screwed axle**, first the aluminium cap on the caster wheel bearing block must be removed. In order to release the cap, you can run under the cap using a commercially available cutter knife and lift slightly at several points. Then the M12 nut (AF 19 mm) is loosened using, e.g. an AF 19 mm socket. Now the caster wheel for rotary

axle can be pulled out from under the caster wheel bearing block.



Figure 103: Aluminium cap



Figure 104: Aluminium cap removed and M12 nut visible

To **assemble the caster fork with screwed axle**, this is inserted into the caster wheel bearing block with the caster wheel for rotary axle. Then the M12 nut (AF 19 mm) is tightened again to 3 Nm and secured with thread lock fluid. Then the aluminium cap is pressed back onto the caster wheel bearing block.

For the rotary axle to run smoothly, the M12 nut must not be tightened to more than 3 Nm. In case more sluggishness is desired, this can be achieved using a higher tightening torque.

22.3.2 Caster forks with quick-release axle

The **caster fork with quick release axle is removed** using the locking knob on the inner side of the caster fork. Grasp around the caster fork and press the locking knob with your thumb. The caster fork can now be pulled out.

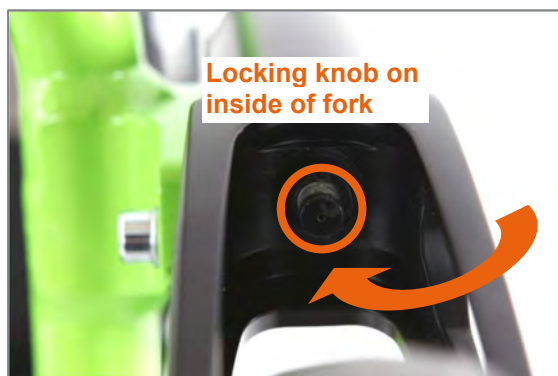



Figure 105: Caster fork with quick release axle and locking knob

When **assembling the caster fork with quick-release axle**, press the locking knob again and insert the caster fork rotary axle into the caster wheel bearing block. When doing this, particular attention must be paid to ensuring that the locking knob springs all the way out again after attaching the fork, as the forks are otherwise not secured correctly. You will know that if you can see the index groove (Fig. 75).

22.4 Adjustment of the caster fork rotary axles

 *The following instructions are intended for and may only be carried out by a rehabilitation specialist dealer or PROACTIV*

To ensure that the product has good properties when steering and driving straight ahead, the caster wheel axle should be adjusted to be vertical to the level ground.

Adjustments on the caster wheel axles can be required for the following reasons:

- The tipping point and/or seat heights have been changed.
- The caster wheel axles are no longer vertical due to a fall or an impact.
- The flatter of the caster wheels should be reduced.

To adjust the caster fork rotary axles, the product should be standing on a level surface and the wheel track of the drive wheels should have already been adjusted (Chapter 21.2).

Now **check** whether the caster fork rotary axles are positioned perpendicular to the level ground. For this purpose, place an angle with height adjustable slider on the front edge of the caster wheel bearing blocks. The slider should be aligned at the middle of the caster wheel bearing block.

Information:

If the front edges of the caster wheel bearing blocks are perpendicular to the level ground, the caster fork rotary axles are as well.

Observe that the front edges of the caster wheel bearing blocks are slightly rounded. Thus, the distance above and below between the slider of the angle and the front edge of the caster wheel bearing blocks must be the same size.

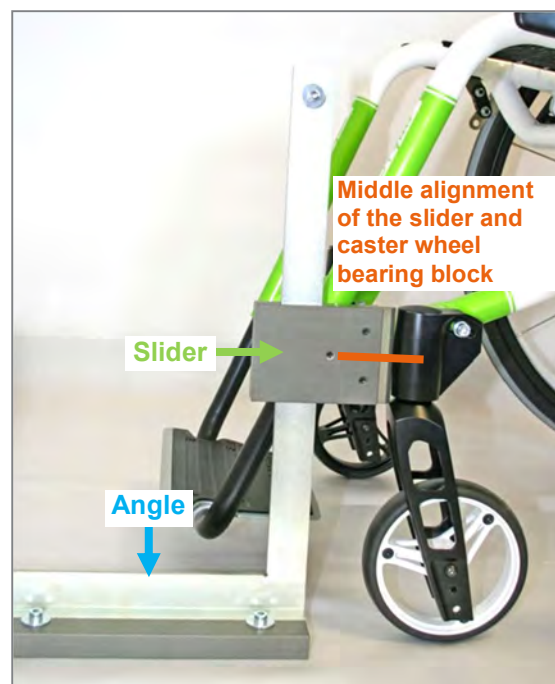

Figure 106: Checking the adjustment of the caster wheel axles

Tool recommendation:

The angle with slider can be ordered from PROACTIV (order number: 8000 901 000).

If the front edges of the caster wheel bearing blocks are not standing vertical to the level ground, the settings must be adjusted. First, **adjust** the right caster wheel bearing block, then the left one, and finally check the right side again. To do this, proceed as follows:

1. Loosen the M5 stud bolt (AF 2.5 mm).



Figure 107: M5 stud bolt

2. Undo the M6 fixing screws (AF 5 mm) slightly on the frame inner side.



Figure 108: M6 fixing screw on frame inner side, washer fitted with G-shape frames but not V-shape frames

3. Now slightly loosen the M6 fixing screw (AF 5 mm) on the outside of the frame.



Figure 109: M6 fixing screw on outer side of product

4. Using the aid of the angle, move the caster wheel bearing block in a vertical position to the level ground.
5. Tighten the M6 fixing screws (AF 5 mm) again on the frame outer and inner side to a tightening torque of 10 Nm and recheck the vertical setting.
6. Screw the M5 stub bolt (AF 2.5 mm) back in so that this rests on the M6 fixing screw.

! After performing adjustment work on the caster wheel bearing block twice, renewing the screw locking fluid for the M6 fixing screws (AF 5 mm) on the outer and inner sides of the frame is recommended.

Note:

To reduce caster wheel flutter, it may be necessary to tilt the caster fork rotary axles from the vertical (Chapter 22.4).

Option:

A clamped variant of the caster wheel bearing block is optionally available on the SPEEDY 4teen. Adjustment of the caster fork rotary axles on this variant is identical to the above description. With the clamped caster wheel bearing blocks, the wheelbase can additionally be changed by moving the caster wheel bearing block on the frame. To move the caster wheel bearing blocks on the frame

tubes, release the two M6 clamp screws (AF 5 mm) on each side. After positioning both caster wheel bearing blocks (make sure the position is the same on the left and right), tighten the M6 clamp screws (AF 5 mm) on both sides to 7 Nm again and lock them with screw locking fluid.



Figure 110: M6 clamp screws on the clamped caster wheel bearing block

23 Footrests

Make sure the clearance under the footrest is sufficient. Experience shows that this should not be less than 4 cm. This must be observed for the angle adjustment of the footplate and when setting the lower leg length.

23.1 Angle adjustment of the footplate

The following instructions are intended for and may only be carried out by a rehabilitation specialist dealer or PROACTIV

The **angle** of the **footplate support** can be set by releasing the M6 fastening clamp screws (AF 5 mm) on the lower side of the footrest support plate. When the angle adjustment is completed, tighten the M6 fastening clamp screws (AF 5 mm) again to maximum 5 Nm. This tightening torque should not be exceeded as higher tightening torques can damage the clamp.



Figure 111: Footrest from below

23.2 Continuous footrest and high-distance footrest



Figure 112: Footrest continuous

For the **longitudinal setting of the footrest support tubes or adaptation to the lower leg length**, the M6 fixing screws (AF 4 mm) must be undone on both sides on the outside of the frame tube. The footrest support tubes are then pushed along their slots and thus brought into the correct position. Observe that the footrest support tubes are both the same length on both sides after they have been adjusted.

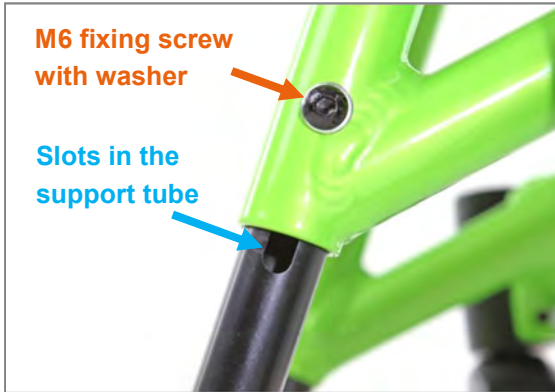

Figure 113: M6 fixing screw with washer and slot in footrest support tube for adjusting the lower leg length

Once the position has been set, fix the footrest support tubes by tightening the M6 fixing screws (AF 4 mm) with washers to 11 Nm on both sides.

Note:

With a V-shaped product frame or with a larger lower leg width at the top than the bottom, it is necessary to relieve the footrest support tube tension in the footrest support plate resulting from longitudinal adjustment. In this case, the M6 fastening clamp screws (AF 5 mm) on the footrest support plate therefore have to be opened before starting to adjust the lower leg length. View the procedure in Chapter 23.1.

23.3 Footrest folding up to one side

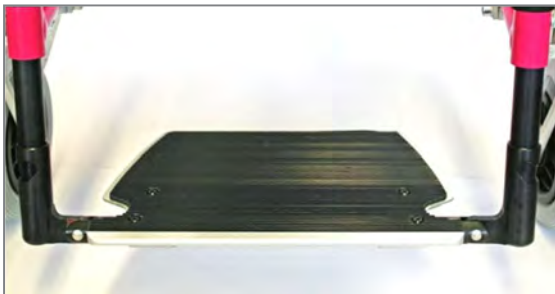

Figure 114: Footrest folding up to one side, standard position

For **footrest folding up to one side**, lift the footplate up in the direction of travel on the left side.

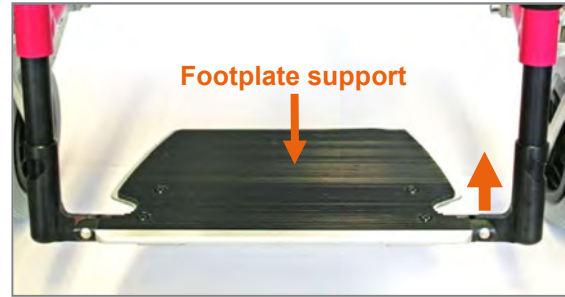

Figure 115: For folding up to one side, lift the footrest up in the direction of travel on the left side (product view from the front)

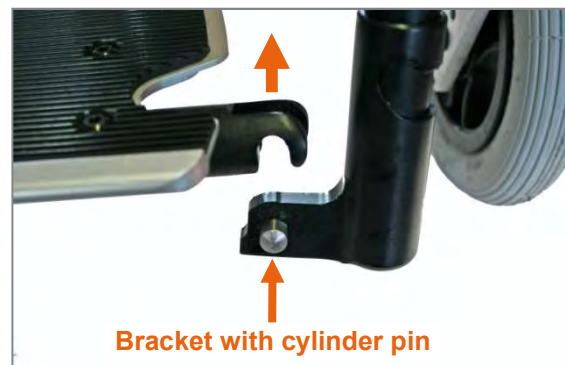

Figure 116: Footplate raised from the bracket (product view from the front)



Figure 117: Footrest folded up on one side (product view from the front)

When you fold the footrest back down, take care that the recesses are resting accurately at the back and front on the cylinder pins of the bracket.

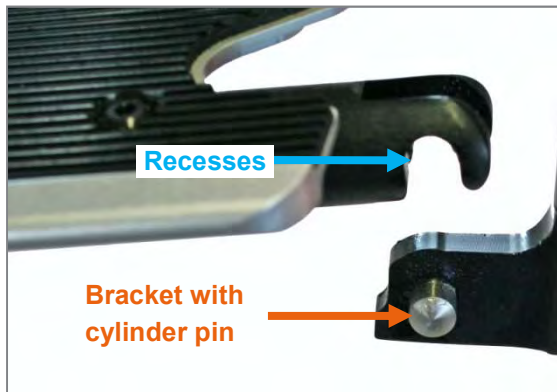

Figure 118: Cylinder pin and corresponding recesses

For the **longitudinal setting of the footrest support tubes or adaptation to the lower leg length**, the M6 fixing screws (AF 10 mm) must be undone on both sides on the outside of the frame tube. The footrest support tubes are then pushed along their slots and thus brought into the correct position. Observe that the footrest support tubes are both the same length on both sides after they have been adjusted.

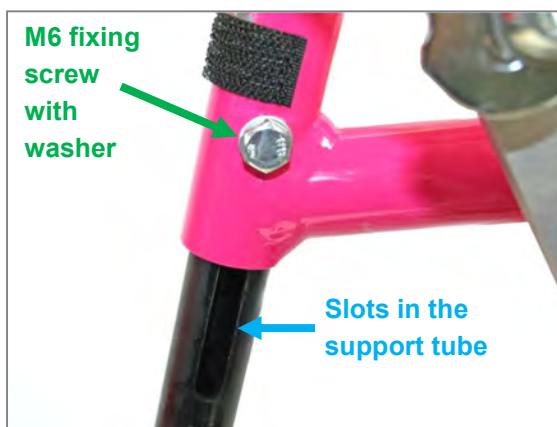

Figure 119: M6 fixing screw with washer and slot in footrest support tube for adjusting the lower leg length

Once the position has been set, fix the footrest support tubes by tightening the M6 fixing screws (AF 10 mm) with washers to 7 Nm on both sides.

Note:

With a V-shaped product frame or with a larger lower leg width at the top than the bottom, it is necessary to relieve the footrest support tube tension in the footrest support plate resulting from longitudinal adjustment or to correct the shifted position of the footplate support. The footplate support can be moved back to the correct position by opening the M6 fastening clamp screws (AF 5 mm) on the footrest support plate. View the procedure in Chapter 23.1.

23.4 Footrest, fold up to the rear



Figure 120: Footrest, fold up to the rear, in standard position

To **fold up the footrest to the rear**, move the locking pin lever on the right and left side to the vertical position to the footbar joints. Now you can move the footrests to the rear.

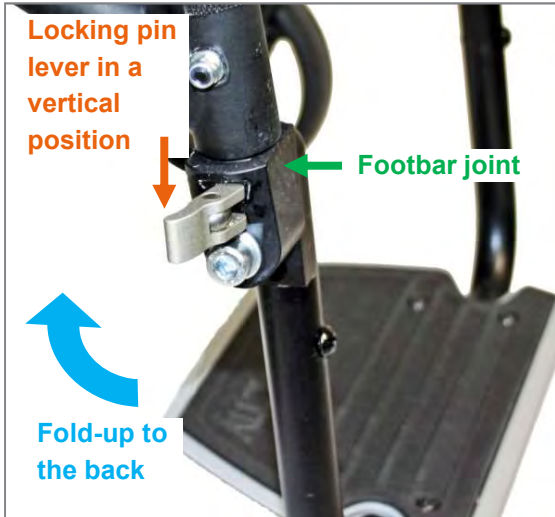

Figure 121: Locking pin lever in a vertical position to the footbar joint, opened

If the footrest should engage in the folded up position, move the locking pin lever back to the horizontal position to the footbar joint. The locking pin levers are now not resting against the footbar joints as the locking pins are not engaged in the locking position yet.



Figure 122: Locking pin lever in horizontal position, not engaged and thus not resting against the footbar joint

As soon as an engaged position is reached during the return movement, the locking pins engage and the levers rest against the footbar joint.



Figure 123: Locking pin lever in horizontal position, engaged and thus resting against the footbar joint

If you want to move the footrest back into the standard position, perform the as previously described and during this process, move the footrest to the front.

After "folding up to the back" each time, make sure that the footrest has engaged correctly again. This is visible when the locking pin lever rests against the footbar joints (Fig. 123).

To **adjust the length of the footrest support tubes or adapt the lower leg length**, the M6 fixing screws (AF 4 mm) on the front sides of the frame tubes must be released on both sides. Fix the footrest support tubes to the inlets using the M6 fixing screws (AF 4 mm) that have 3 holes that serve the setting of the lower leg length. Only an extension of the lower leg length is possible as the footrest support tube is always fixed in the top hole of the inlet.



Figure 124: M6 fixing screw with washer to adjust the lower leg length



Figure 125: Inlet with 3 holes (view without footrest support tube)

Once the M6 fixing screws (AF 4 mm) have been loosened on both sides, move the footrest support tubes so that the holes on both sides of the footrest support tubes are positioned accurately over the holes underneath. Take care that the same holes are used on both sides.

Once the position has been set, fix the footrest support tubes by tightening the M6 fixing screws (AF 4 mm) with washers to 11 Nm on both sides.

23.5 Footrest, folding up to the rear, with spring latching mechanism



Figure 126: Footrest, folding up to the rear, with spring latching mechanism, in standard position

To **fold the footrest up to the rear**, the footplate must be pushed gently backwards until the footrest is released from the lock. Now the footrest can be folded up completely to the rear.



Figure 127: Footrest, folding up to the rear, with spring latching mechanism, folded up to the rear

If you want to return the footrest to the standard position again, push it back forwards to the standard position.

To **adjust the length of the footrest support tubes or adapt the lower leg length**, the M6 fastening clamp screws (with polymer dry locking coating, AF 4 mm) must be unscrewed on both outer sides of the lower leg tubes. The lower leg length can now be adjusted along the notches. Make sure that the same notch is used on both sides.

A large adjustment range is available for a shorter lower leg length. If a longer lower leg length is desired, it can usually be extended by 2°cm with the existing lower leg tube. If a greater extension is desired, longer lower leg tubes can be obtained from PRO ACTIV.

Once the lower leg length is adjusted, fix it in position by inserting the M6 fastening clamp screws (with polymer dry locking coating, AF 4 mm) on both sides and tightening them to 7 Nm.

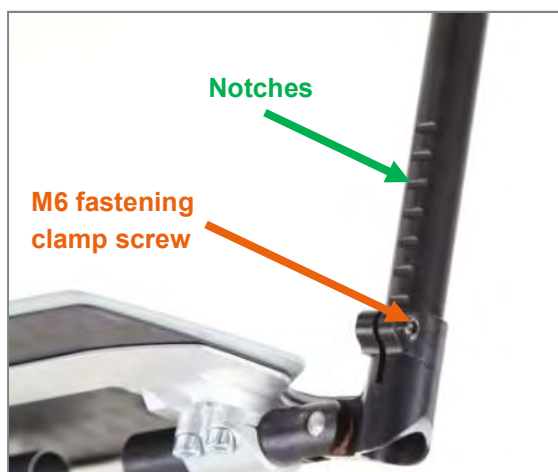

Figure 128: Notches and M6 fastening clamp screw for lower leg length adjustment (view from the rear)

Note:

With a V-shaped product frame or with a larger lower leg width at the top than the bottom and footrest support tubes that do not run parallel, it is necessary to relieve the footrest support tube tension in the footrest support plate resulting from longitudinal adjustment. In this case, the M6 fastening clamp screws (AF 5 mm) on the footrest support plate therefore have to be opened before starting to adjust the lower leg length. View the procedure in Chapter 23.1.

23.6 Divided footrest

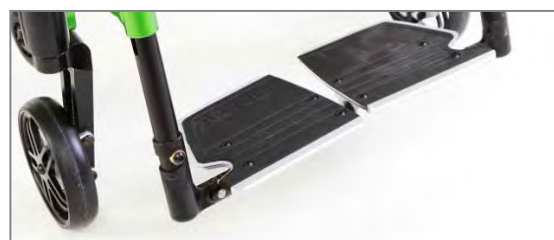

Figure 129: Centrally divided footrest, in standard position

To **fold up** one of the two footrest parts, grasp it and fold it up to the side. Moreover, you can also turn or **pivot the footrest outwards**.

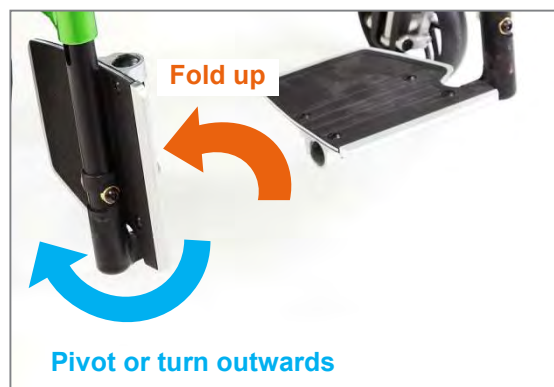

Figure 130: One footrest folded up, option for pivoting outwards marked

For the **longitudinal setting of the footrest support tubes or adaptation to the lower leg length**, the M6 fixing screws (AF 10 mm) must be undone on both sides on the outside of the frame tube. The footrest support tubes are then pushed along their slots and thus brought into the correct position. Observe that the footrest support tubes are both the same length on both sides after they have been adjusted.

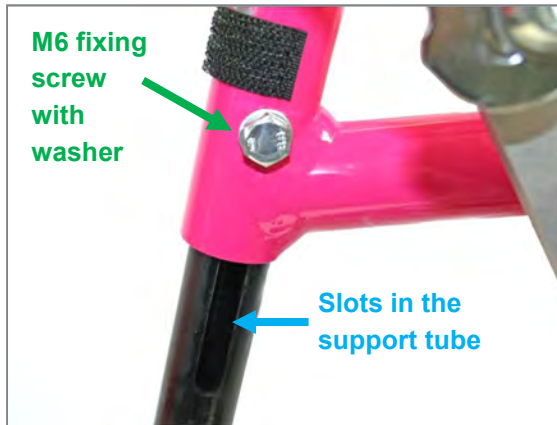

Figure 131: M6 fixing screw with washer and slot in footrest support tube for adjusting the lower leg length

Once the position has been set, fix the footrest support tubes by tightening the M6 fixing screws (AF 10 mm) with washers to 7 Nm on both sides.

Note:

With a V-shaped product frame or with a larger lower leg width at the top than the bottom, it is necessary to correct the resulting, shifted position of the footplate supports. The footplate support plates can be moved back to the correct position by opening the M6 fastening clamp screws (AF 5 mm) on the footrest support plates. View the procedure in Chapter 23.1.

23.7 Swing away footrest



Figure 132: Swing away footrest, in standard position

To **fold up** one of the two footrest parts, grasp it and fold it up to the side. Moreover, you can also turn or pivot the footrest outwards.



Figure 133: Both footrest parts folded up and pivoted outwards

To **remove** the footrest parts, place the locking pin lever vertical to the bracket towards the front on both sides and then pull both footrest parts upwards out of the bracket.

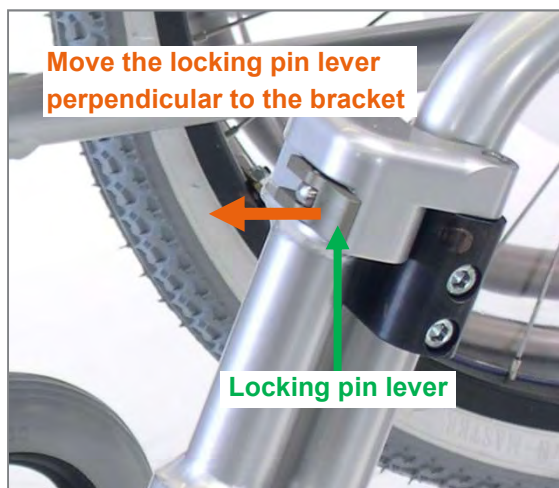

Figure 134: Moving locking pin lever perpendicular to remove swing away footrest

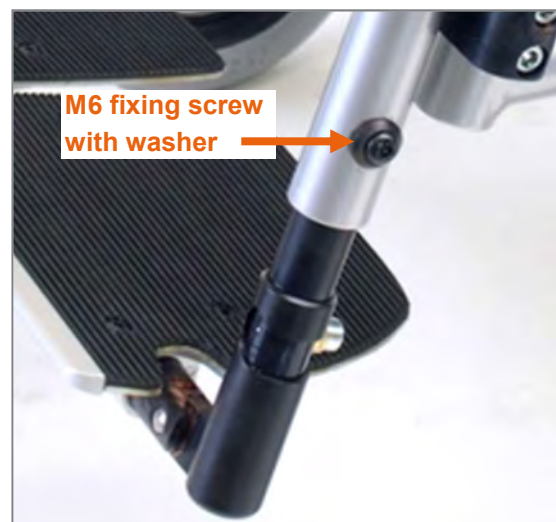



Figure 136: M6 fixing screw with washer to adjust the lower leg length



Figure 135: Swing away footrest removed

Once the position has been set, fix the footrest support tubes by tightening the M6 fixing screws (AF 4 mm) with washers to 11 Nm on both sides.

23.8 Safety instructions

 Ensure when setting the lower leg length, that no strong pressure is produced between the underneath of the lower leg of the wheelchair user and the edge of the seating system.

24 Anti-tipping support

To minimise the risk of tipping backwards unintentionally, anti-tipping supports are available as accessories. The anti-tipping supports are adapted to the axle tube via anti-tipping support adapters and can be swivelled under the frame using a spring system.

To **adjust the length of the footrest support tubes or adapt the lower leg length**, the M6 fixing screws (AF 4 mm) must be released on both sides. The footrest support tubes are then pushed along their slots and thus brought into the correct position. Observe that the footrest support tubes are both the same length on both sides after they have been adjusted.

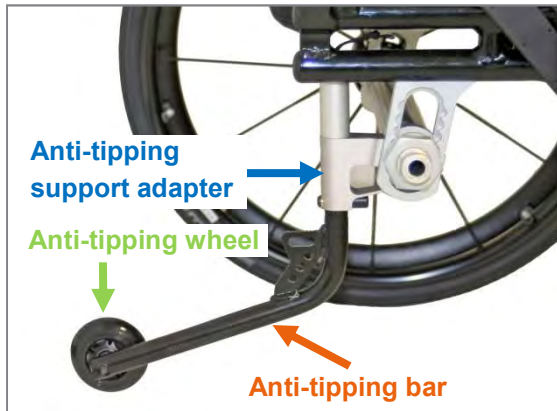

Figure 137: Anti-tipping support

24.1 Operating and passive position

To overcome an obstacle, the anti-tipping support must be swivelled from the operating to the passive position beforehand so that this does not knock against the obstacle.



Figure 138: Operating position of anti-tipping support (view from the rear)



Figure 139: Passive position of anti-tipping support (view from the rear)

To move the **anti-tipping support into the operating position**, press the anti-tipping bar downwards and swivel this to the rear. Make sure that the anti-tipping support is engaged correctly again. This is visible when the footstep pins have engaged in the corresponding recess of the anti-tipping support adapters from the one side and the M6 fixing screws from the other side.

Recommendation:

An accompanying person can also press the anti-tipping support downwards by stepping on the footstep pin and then swivelling it into the operating position.



Figure 140: Moving the anti-tipping support to operating position (view from the rear)



Figure 141: Anti-tipping support engaged correctly

To move the **anti-tipping support into the passive position**, press the anti-tipping bar downwards and swivel this to the inside underneath the seating area. Make sure that the anti-tipping support is engaged correctly again. This is visible when the footstep pins have engaged in the corresponding recess of the anti-tipping support adapters from the one side and the M6 fixing screws from the other side.

Recommendation:

An accompanying person can also press the anti-tipping support downwards by stepping on the reinforcement plate and then swivelling it into the passive position.

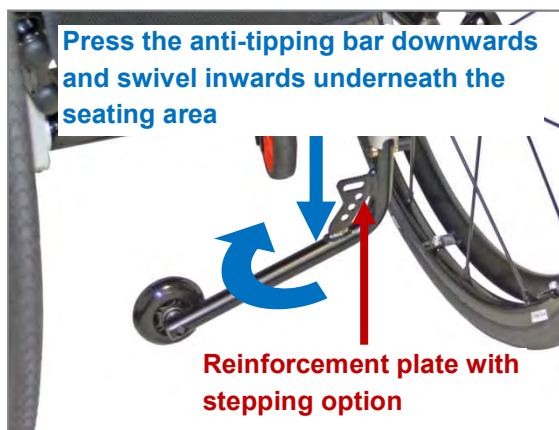



Figure 142: Moving the anti-tipping support to passive position (view from the rear)

24.2 Removing and attaching the anti-tipping support

 The following instructions are intended for and may only be carried out by a rehabilitation specialist dealer or PROACTIV

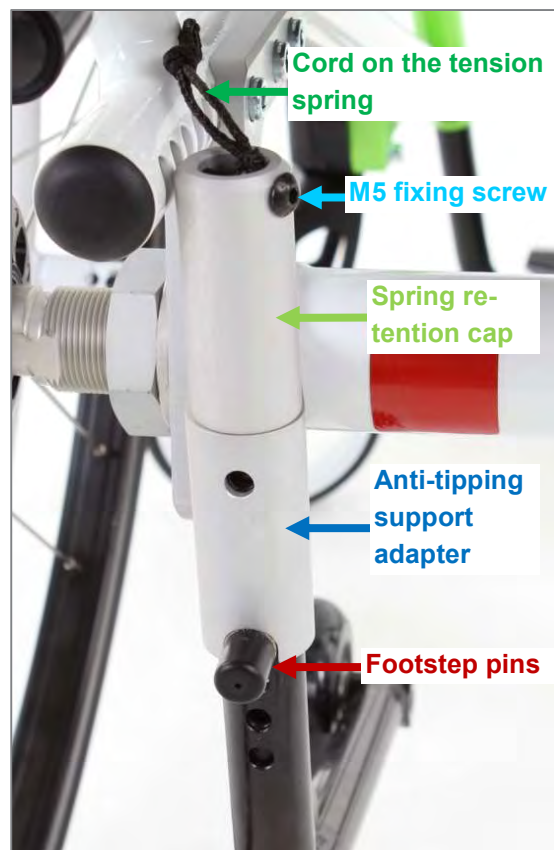

Figure 143: Overview of terms

To **remove** the anti-tipping support, the M5 fixing screw (AF 3 mm) is screwed out of the spring retention cap and at the same time, the cord that is fixed to the tension spring is retained. Now the cord can be released and the anti-tipping bar can be removed from the anti-tipping support adapter downwards. The spring retention cap must also be removed. In order to prevent losing the M5 fixing screw, this is screwed back into the spring retention cap.

To **install** the anti-tipping support, the anti-tipping bar is inserted into the anti-tipping support adapter from underneath and pulled upwards using the cord. In doing so, the M6 fixing screw must engage on the side of the footstep

pin and on the other side, in the recess of the anti-tipping support adapter.

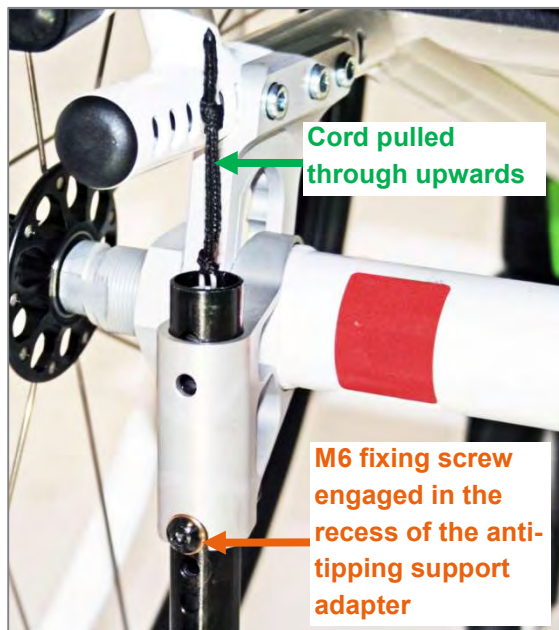

Figure 144: Anti-tipping bar inserted into the anti-tipping support adapter

Now the anti-tipping supports are held at the bottom on the anti-tipping bar in this position and the spring retention cap is put onto the anti-tipping support adapter (loosen the M5 fixing screw on the spring retention cap first in case this have been screwed in not to loose it) so that the cord protrudes from the top.

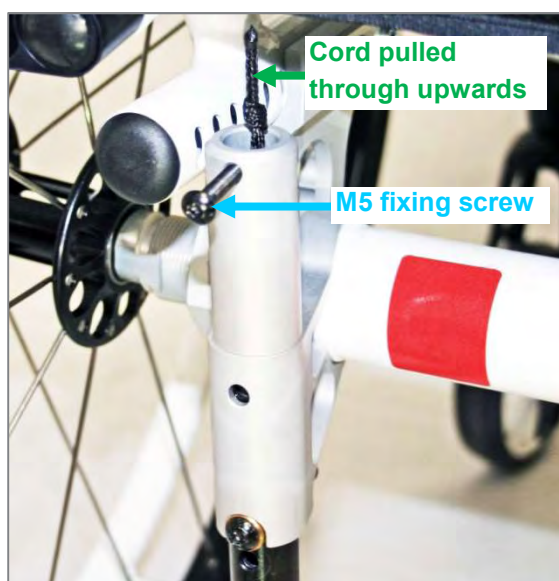

Figure 145: Spring retention cap placed on the anti-tipping support adapter, cord pulled through upwards and M5 fixing screw inserted

Finally, the cord is strongly pulled upwards until the tension spring becomes visible at the top of the spring retention cap (this must be held tight in the process). At the same time, the M5 fixing screw (AF 3 mm) is screwed back into the spring retention cap and through the end eyelet of the tension spring. The M5 fixing screw (AF 3 mm) must be secured using screw locking fluid.

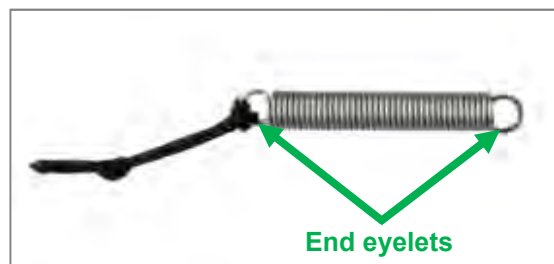

Figure 146: Tension springs with end eyelets



Figure 147: The M5 fixing screw screwed through the end eyelets of the tension spring

24.3 Height adjustment of the anti-tipping support

The following instructions are intended for and may only be carried out by a rehabilitation specialist dealer or PROACTIV

This must be removed first for the height adjustment of the anti-tipping support (see Chapter 24.2). The footstep pin is then removed via

the M6 fixing screw (AF 4 mm) to which the tension spring is secured at the bottom. When loosening the M6 fixing screw, the footstep pin must be held using pliers (the footstep pin must be protected from scratching while being held with pliers). After removing the M6 fixing screw, the tension spring can be removed.

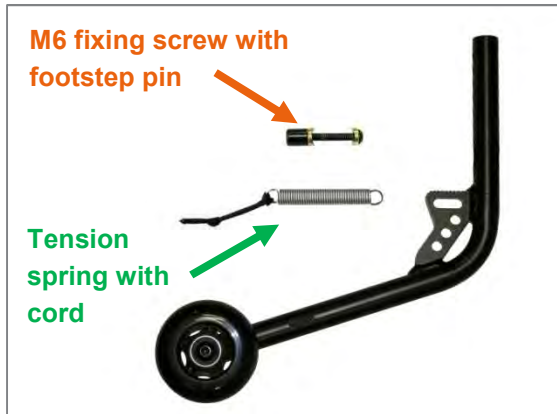

Figure 148: M6 fixing screw and tension spring removed from anti-tipping bar

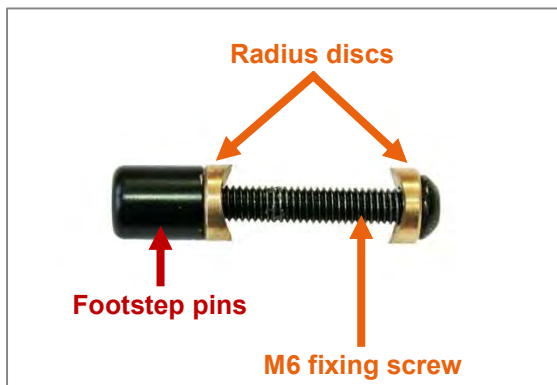

Figure 149: M6 fixing screw with radius discs and footstep pin

There is an inlet within the anti-tipping bar that must be adjusted to the new height position. The inlet should be positioned as low as possible in the anti-tipping bar. A screwdriver could be used for the positioning of the inlets, for example.



Figure 150: Inlet of the anti-tipping bar and the screwdriver

Now the tension spring is positioned in the inlet so that the end eyelet of the tension spring is positioned precisely over the borehole in which the M6 fixing screw shall then be screwed in to. Once the inlet and the tension spring have been positioned correctly, the M6 fixing screw (with both radius discs and the footstep pin) (AF 4 mm) is screwed into the new height position through the inlet and the end eyelet of the tension spring.

Finally, reattach the anti-tipping support to the product as described in Chapter 24.2.

24.4 Safety instructions

⚠ The anti-tipping support is designed exclusively to minimise the risk of tipping over backwards. It is not suitable for reducing the risk of tipping forwards or to the side. There is no safety equipment on offer for minimizing these risks. For this reason, handling these risks need to be learnt in cooperation with your therapists and doctors.

⚠ Before using the product, each time after loading the anti-tipping supports and after every adjustment to the product, make sure that the anti-tipping supports are fully functional. In this case, it must not be possible to swivel the anti-tipping supports to the side when in operating position without having to unlock them first.

 The lower edge of the anti-tipping wheels may not be more than 5 cm from the ground. If a larger gap is required or necessary, then you need to work with your therapists and doctors to practice and learn to handle the increased risk of tipping.

 If the functional capability of the anti-tipping supports is no longer ensured or if you are in any doubt about their flawless function, have them checked by your rehabilitation specialist dealer and repaired before any further use. Otherwise there is an increased risk or falling of getting injured.

25 Brakes

25.1 Knee lever brake

25.1.1 Opening and closing the brake

The knee lever brake can be equipped with various brake levers, such as, e.g. standard brake levers, long brake levers, extended brake levers, fold-down brake levers and brake levers with plastic balls. The brake lever can be mounted in the standard position, or low. The knee lever brake can also be selected with one-hand operation, in which case only one brake lever is present on the right or left. However, operation is identical for all of these brake levers.



Figure 151: Knee lever brake system with standard brake lever



Video Knee lever brake with one-hand operation

The **brake is closed** by pushing the brake lever forwards and downwards. In the closed position, the brake pin pushes the tyre in by approx. 4 mm (at the specified air pressure in the tyre).

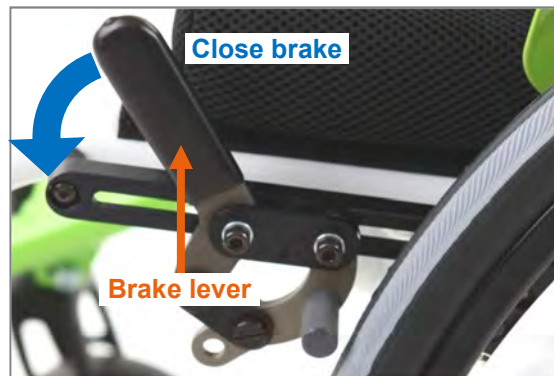



Figure 152: Brake opened, closed by pushing the brake lever forwards and downwards

 Please note that the knee lever brake is a parking brake which may only be applied when the product is at a standstill. This is not a service brake which is suitable for reducing speed.

To **open the brake**, pull the brake lever back up and rearwards again. In the open position, the distance between the brake pin and the tyre is approx. 3 to maximum of 4 mm.

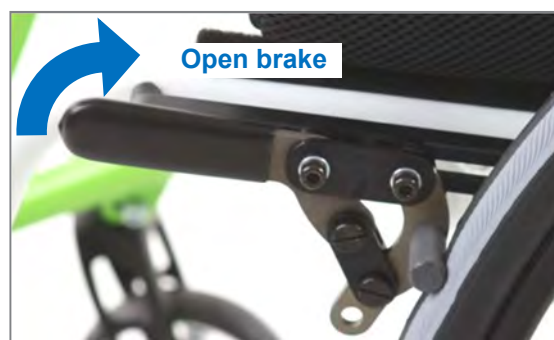



Figure 153: Brake closed; opening done by pulling the brake lever up and rearwards

25.1.2 Brake adjustment on the SPEEDY 4all, SPEEDY 4you and SPEEDY 4teen models

 *The following instructions are intended for and may only be carried out by a rehabilitation specialist dealer or PROACTIV*

Settings on the brake could be necessary for the following reasons:

- You have changed the tyre or the tyre pressure.
- You have changed the wheel tracking or the position of the drive wheels.
- The brake is pulling unevenly or insufficiently after extended use.

To adjust the knee lever brake, proceed as follows on both sides:

1. Initial situation: Drive wheels mounted on the product and the knee lever brakes open. The drive wheels have the specified inflation pressure.
2. For the **correct positioning** of the knee lever brake, slightly loosen the M5 clamp screws (AF 4 mm) so that the knee lever brake can be moved on the brake holding rail.



Figure 154: M5 fixing screws on the brake holding rail

3. Position the opened brake on the brake holding rail so that there is a distance of between approx. 3 to max. 4 mm between the brake pin and the tyre.



Figure 155: Distance between the brake pin and tyre of from approx. 3 to max. 4 mm with the brake opened

4. Tighten the M5 fixing screws (AF 4 mm) again to 4 Nm.
5. Then check the correct setting of the brakes: On a slope (7° gradient) the product should stand firm with the brake applied. This is the case if, with the brake applied, the tyre is depressed or deformed by approximately 4 mm by the brake pin (at the specified tyre inflation pressure). When the brake is open, the distance between the brake pin and the tyre is approx. 3 to maximum 4 mm.
6. The **actuating force** of the brake lever can be adjusted using the M5 joint screws and M5 nuts. For this purpose, you need a slotted screwdriver and an open-ended spanner (AF 8 mm). The screw is held at the front with the slotted screwdriver and the open-ended spanner (AF 8 mm) is used to tighten or loosen the nut at the rear. An important point here is that both joint screws must be tightened equally as this leads to a long-lasting uniform actuating force of the brake lever.

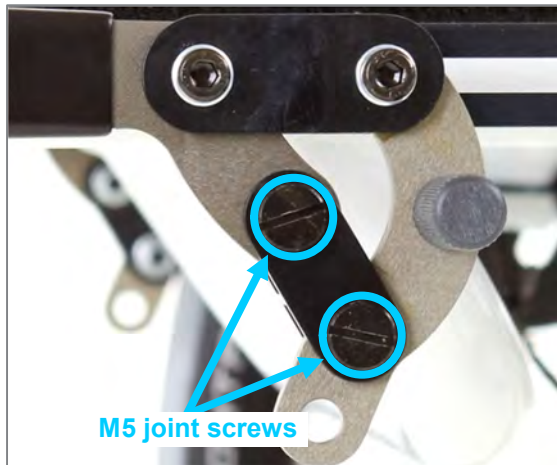

Figure 156: M5 joint screws for setting the actuating force of the brake lever

Note:

The brake pin is usually mounted in the standard position (see following figure). The assembly of the brake pin in the other possible position (see following figure) may be necessary after the adjustment of the drive wheels.

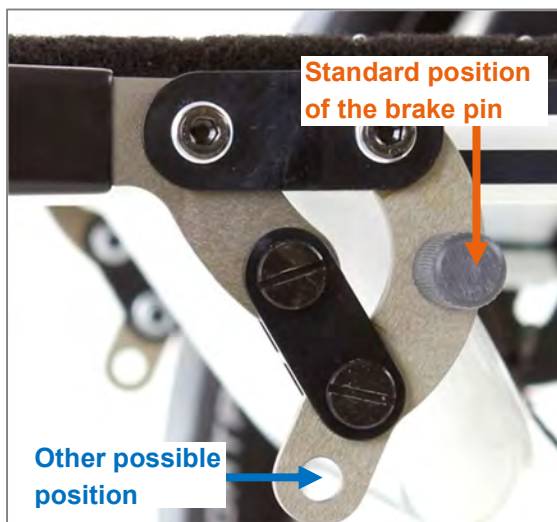



Figure 157: Positions of the brake pin

25.1.3 Brake adjustment on the SPEEDY 4all Ergo and SPEEDY 4you Ergo models

 The following instructions are intended for and may only be carried out by a rehabilitation specialist dealer or PROACTIV

Settings on the brake could be necessary for the following reasons:

- You have changed the tyre or the tyre pressure.
- You have changed the wheel tracking or the position of the drive wheels.
- The brake is pulling unevenly or insufficiently after extended use.

To adjust the knee lever brake, proceed as follows on both sides:

1. Initial situation: Drive wheels mounted on the product and the knee lever brakes open. The drive wheels have the specified inflation pressure.
2. For the **correct positioning** of the knee lever brake, slightly loosen the M5 clamp screws (AF 4 mm) so that the knee lever brake can be moved on the hexagon rail.

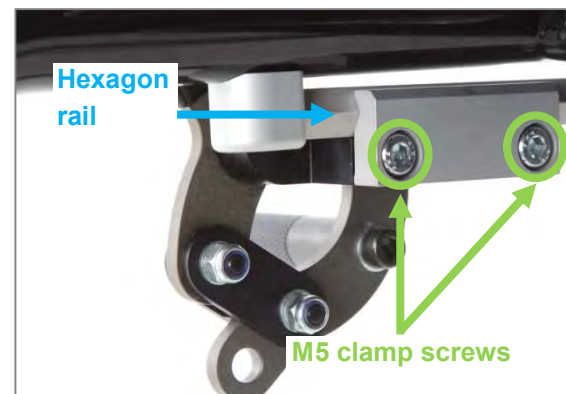

Figure 158: M5 clamp screws on the hexagon rail (view from the inner side of the product)

3. Position the opened brake on the hexagon rail so that there is a distance of approx. 3 to max. 4 mm between the brake pin and the tyre.



Figure 159: Distance between brake pin and tyre of approx. 3 mm to maximum 4 mm, with opened brake



Figure 160: M5 joint screws for setting the actuating force of the brake lever

4. Tighten the M5 clamp screws (AF 4 mm) to 4 Nm again.
5. Then check the correct setting of the brakes: On a slope (7° gradient) the product should stand firm with the brake applied. This is the case if, with the brake applied, the tyre is depressed or deformed by approximately 4 mm by the brake pin (at the specified tyre inflation pressure). When the brake is open, the distance between the brake pin and the tyre is approx. 3 to maximum 4 mm.
6. The **actuating force** of the brake lever can be adjusted using the M5 joint screws and M5 nuts. For this purpose, you need a slotted screwdriver and an open-ended spanner (AF 8 mm). The screw is held at the front with the slotted screwdriver and the open-ended spanner (AF 8 mm) is used to tighten or loosen the nut at the rear. An important point here is that both joint screws must be tightened equally as this leads to a long-lasting uniform actuating force of the brake lever.

Note:

The brake pin is usually mounted in the standard position (see following figure). It may be necessary to mount the brake pin in the other possible position (see following figure) after adjusting the drive wheels.

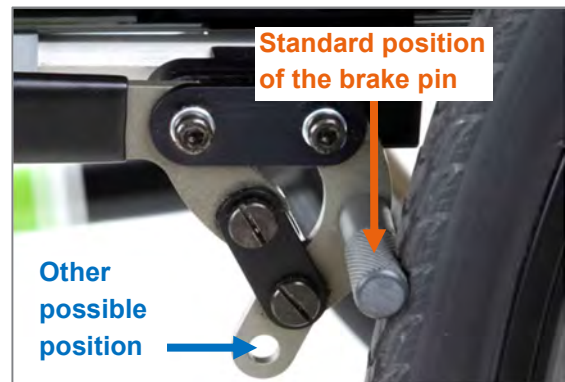

Figure 161: Positions of the brake pin

25.2 Integral parking brake

25.2.1 Opening and closing the brake

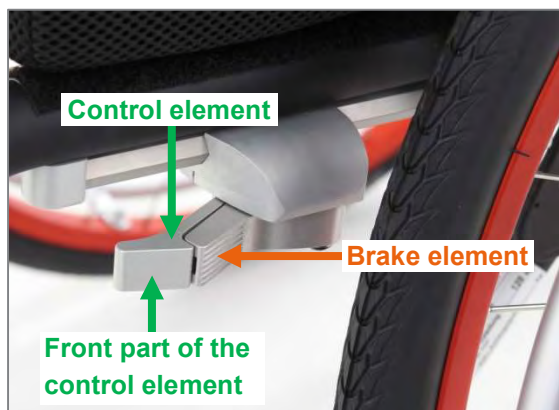

Figure 162: Overview of terms

Closing the brake is carried out by pressing the front part of the control element to the right or left outwards until the brake element rests against the tyre. Then press the control element (on the front part) towards the tyre until the control element rests against the brake element and the brake noticeably engages.

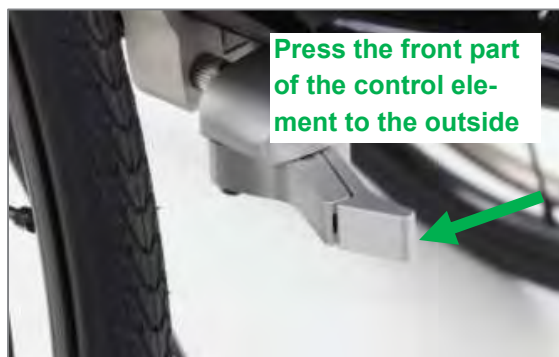

Figure 163: Integral brake open, closing is carried out by pressing the control element outwards

With the brake closed, the brake element is perpendicular to the brake mount and the brake element pushes approximately 4 mm into the tyre (with the specified air pressure in the tyres).

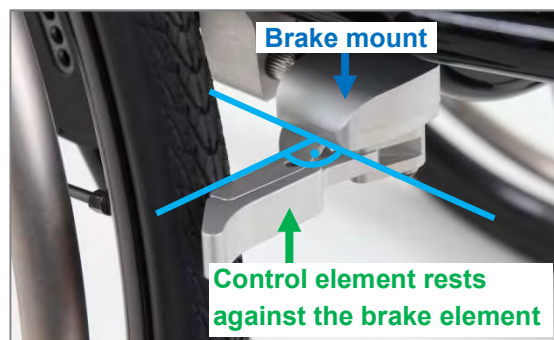

Figure 164: Integral brake closed, brake element vertical to the brake mount

Please note that the integral brake is a parking brake which may only be applied when the product is at a standstill. This is not a service brake which is suitable for reducing speed.

To **open the brake**, press the front part of the control element towards the middle of the wheelchair (away from the wheel).



Figure 165: Integral brake closed, the brake is opened by pressing the control element towards the middle of the wheelchair

When opening and closing the brakes, make sure that the control and brake element are never grasped. Press the brake only using one finger or with the ball of your hand on the front part of the control element.

25.2.2 Brake adjustment with standard installation (Ergo models)

 *The following instructions are intended for and may only be carried out by a rehabilitation specialist dealer or PROACTIV*

Settings on the brake could be necessary for the following reasons:

- You have changed the tyre or the tyre pressure.
- You have changed the wheel tracking or the position of the drive wheels.
- The brake is pulling unevenly or insufficiently after extended use.

To adjust the integral brake with standard installation (Ergo models), proceed as follows on both sides:

1. Initial situation: Drive wheels mounted on the product and the integral brakes open. The drive wheels have the specified inflation pressure.
2. Slightly loosen the M5 clamp screws (AF 4 mm) so that the brake mount can be moved on the hexagon rail.

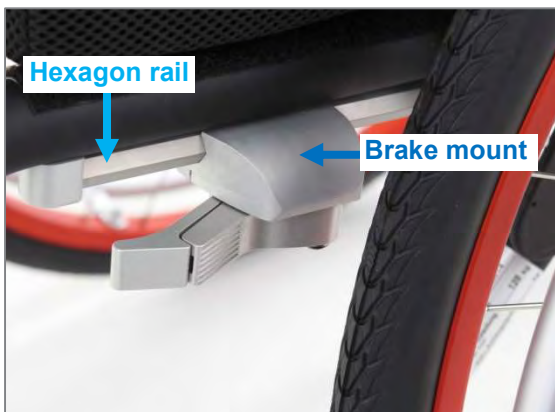

Figure 166: Hexagon rail and brake mount

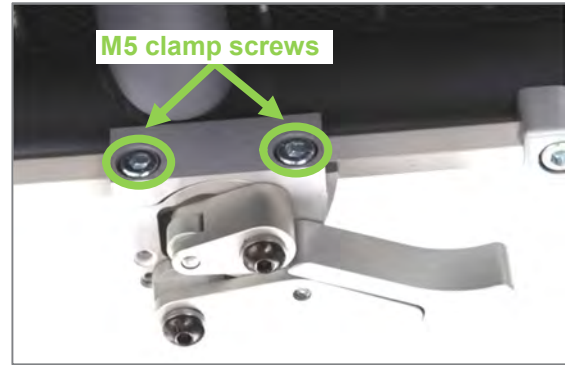

Figure 167: M5 clamp screws for positioning the integral brake (view from inner side of product)

3. Press the front part of the control element to the right or left outwards until the brake element rests against the tyre. Do not close the brake completely.



Figure 168: Brake element resting on the tyre

4. Move the integral brake on the hexagon rail so that the brake element is positioned as shown in the following figure:

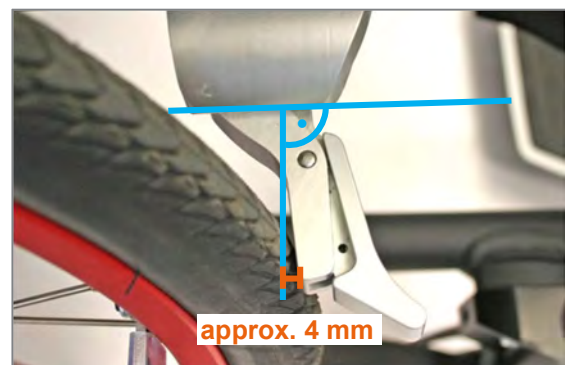



Figure 169: Brake element after correct positioning of the integral brake

5. Tighten the M5 clamp screws (AF 4 mm) to 4 Nm again.
6. Then check the correct setting of the brakes: On a slope (7° gradient) the product should stand firm with the brake applied. This will happen if, with the brake closed, the tyre is depressed or deformed by approximately 4 mm by the brake element (at prescribed air pressure in the tyres).

25.2.3 Brake adjustment for installation with clamping bracket

 *The following instructions are intended for and may only be carried out by a rehabilitation specialist dealer or PROACTIV*

Settings on the brake could be necessary for the following reasons:

- You have changed the tyre or the tyre pressure.
- You have changed the wheel tracking or the position of the drive wheels.
- The brake is pulling unevenly or insufficiently after extended use.

To adjust the integral brake with clamping bracket, proceed as follows on both sides:

1. Initial situation: Drive wheels mounted on the product and the integral brakes open. The drive wheels have the specified inflation pressure.
2. Undo the M5 clamp screws (AF 4 mm) slightly so that the integral brake can be pushed in the clamping bracket with splined shaft.

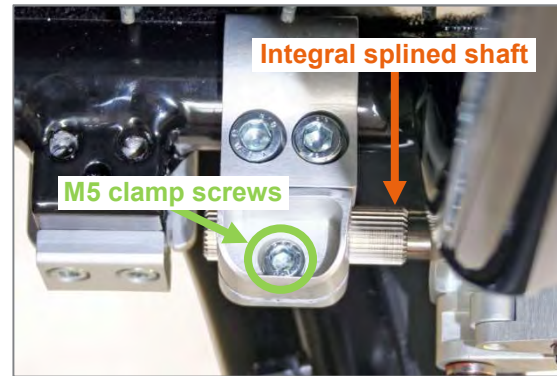

Figure 170: M5 clamp screw for moving the integral brake with integral splined shaft in the clamping bracket (view from the inner side of the product)

If this adjustment range is insufficient, undo the M6 grub screw (AF 3 mm) and the M6 clamp screw (AF 5 m) of the clamping bracket slightly so that the clamping bracket can be moved along the frame tube.

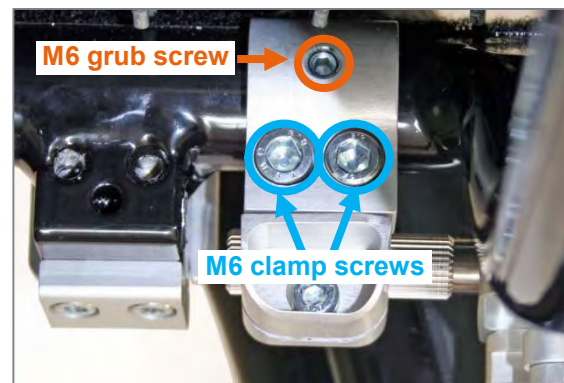

Figure 171: M6 grub screw and M6 clamp screw for moving the clamping bracket on the frame tube (view from the inner side of the product)

3. Press the front part of the control element to the right or left outwards until the brake element rests against the tyre. Do not close the brake completely.



Figure 172: Brake element resting on the tyre

4. Move the integral brake with splined shaft in the clamping bracket and on the frame so that the brake element is positioned as shown in the following figure:

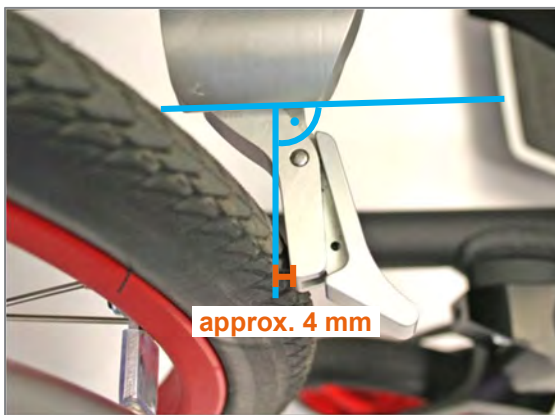

Figure 173: Brake element after correct positioning of the integral brake

5. Tighten the M5 clamp screw (AF 4 mm) to 4 Nm again and, where applicable, the M6 clamp screw (AF 5 mm) to 10 Nm. Then also, where applicable, screw the M6 grub screw (AF 3 mm) back in until it rests against the product frame.

6. Then check the correct setting of the brakes: On a slope (7° gradient) the product should stand firm with the brake applied. This will happen if, with the brake closed, the tyre is depressed or deformed by approximately 4 mm by the brake element (at prescribed air pressure in the tyres).

25.3 Parking knee lever brake for accompanying person



Figure 174: Brake handle on the pushing device

To **actuate the parking knee lever brake**, use the brake handles on the pushing device of the product and actuate the locking lever.

To **release the parking knee lever brake**, actuate the locking lever again and thus release the brake lock.

The brake handles with locking lever can be mounted on push handles offset to the back or a central push handle.

 Please note that the knee lever brake is a parking brake which may only be applied when the product is at a standstill. This is not a service brake which is suitable for reducing speed.

25.4 Knee lever brake with lock



Figure 175: Knee lever brake with lock

To release or apply the knee lever brake, pull the locking knob out of its lock and turn it 90°. The brake lever can then be used to apply or release the brake.



Figure 176: Locking knob pulled out of lock and turned 90°

The **brake is closed** by pushing the brake lever forwards and downwards. In the closed position, the brake pin pushes the tyre in by approx. 4 mm (at the specified air pressure in the tyre).

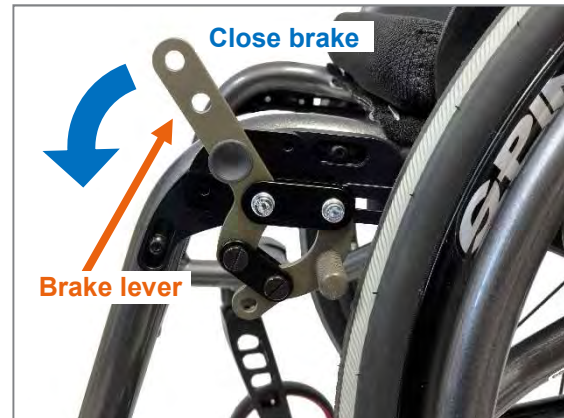

Figure 177: Brake opened, closed by pushing the brake lever forwards and downwards

⚠ Please note that the knee lever brake is a parking brake which may only be applied when the product is at a standstill. This is not a service brake which is suitable for reducing speed.

To **open the brake**, pull the brake lever back up and rearwards again. In the open position, the distance between the brake pin and the tyre is approx. 3 to maximum of 4 mm.

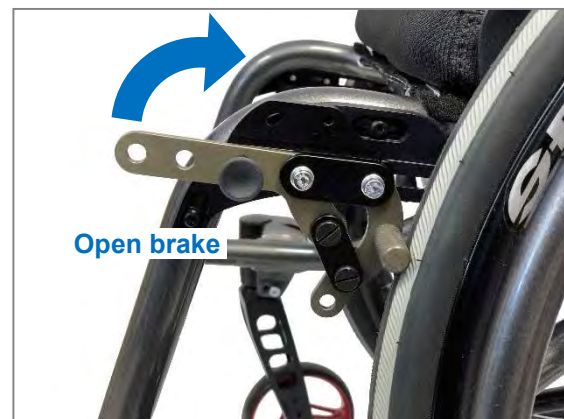

Figure 178: Brake closed; opening done by pulling the brake lever up and rearwards

To **lock** the brake position, turn the locking knob 90° and allow it to engage in the intended hole in the locking block.

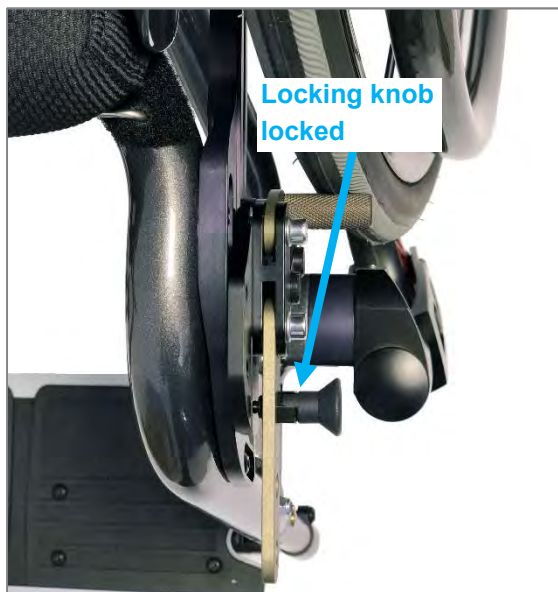

Figure 179: Locking knob engaged in locking block

25.5 Drum brake



Figure 180: Drum brake



Figure 181: Brake handle on the pushing device with locking lever

To **actuate the drum brakes**, use the brake handle on the pushing device of the product. The drum brake is a service brake and can be operated when travelling for reducing the speed. In order to use the drum brake as parking brake, also operate the locking lever.

To **open the drum brake**, actuate the locking lever again and thus release the parking brake of the brake.

26 Push handles

26.1 Back tube with integrated handles



Figure 182: Back tube with integrated handles

With these push handles, there is no option for adjustment and no possibility to remove the handle.

26.2 Aluminium push handles fixed in back tube



Figure 183: Aluminium push handles fixed in back tube

It is not possible to adjust these push handles.

To **remove** the push handles, undo the M6 fixing screws (AF 4 mm) with washer on both sides. The push handles can then be pulled out from the back tubes.

To **install** the push handles, place these in the back tube and insert the M6 fixing screws (AF 4 mm) (with washers) into the each of the holes of the back tube and push handle. Tighten the M6 fixing screws (AF 4 mm) to 11 Nm torque and secure them with thread lock fluid.

26.3 Push handles, horizontally screwed in back tube



Figure 184: Push handles, horizontally screwed in back tube

It is not possible to adjust these push handles.

To **remove** the push handles, turn these counter-clockwise out of the back tube.



Figure 185: Screw the push handle horizontally out of the back tube

To **install** the push handle, turn it into the back tube clockwise and tighten it to a maximum hand tightness.

26.4 Safety push handles with continuous height adjustment

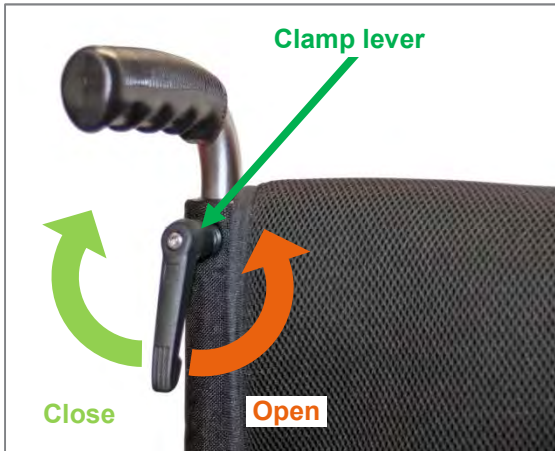

Figure 186: Safety push handles with infinite height adjustment

For **adjusting the height** of the push handles, open the clamp lever by turning counter-clockwise (a half to a complete rotation). Then the height of the push handles can be adjusted. The height can be infinitely adjusted. We recommend adjusting both push handles to the same height. Once the desired height is set, hold the push handles in this position and then close the clamp lever again clockwise with a half to complete rotation.

Note:

If the clamp lever knocks against the push handle when turning it, you can pull the clamp lever out perpendicular to the rotary axle, release it again in another angle position via the integrated serration and keep on turning. This also permits the position of the clamp lever to be aligned to the back tube after performing the height setting so that this does not protrude over the back tube to the side.



Video Safety push handles with continuous height adjustment



Figure 187: Put the clamp lever in another angled position by pulling out

To **remove** the push handles, turn the clamp lever out on each side (by turning anti-clockwise). Then the push handle can be removed from the back tube.

To **attach** the push handles, insert them into the back tubes. Then insert the clamp lever into the hole in the back tube and the push handle thread. Finally, tighten the clamp lever again (by turning clockwise).

26.5 Safety push handles back-positioned

Adjusting the height of push handles offset to the back is possible without tools using the quick release levers. For adjusting, the quick release levers are opened and closed again after adjusting. The height can be infinitely adjusted. We recommend adjusting both push handles to the same height.



Video Height adjustment of safety push handles offset to the back

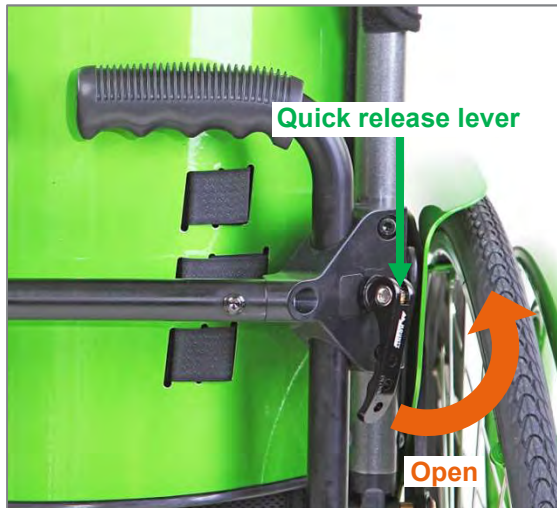



Figure 188: Closed quick release lever

To **remove** the push handle, the M4 end stop screw (AF 3 mm) needs to be unscrewed and the quick release lever needs to be opened.



Figure 189: M4 end stop screw mounted at the bottom of a push handle offset to the back

To **attach** them, the push handles are inserted and held at the correct height, and the quick release levers are closed. Finally, the M4 end stop screws (AF 3 mm) are screwed in again.

 If necessary the tension can be adjusted by turning the quick release lever clockwise until it reaches the end stop.

 Each time prior to use, the M4 end stop screws (AF 3 mm) must have been mounted again.

Equipment option:

The push handles on the SPEEDY 4teen are also optionally available with lateral handle offset.

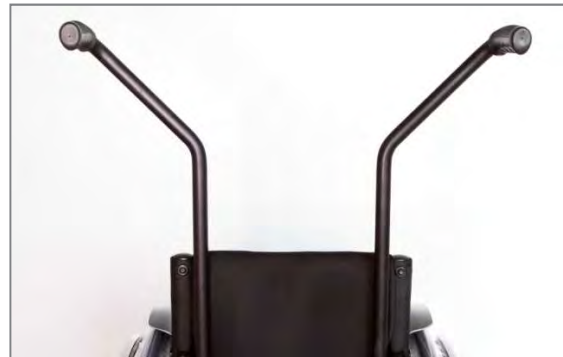

Figure 190: Push handles, offset to the back, with lateral handle offset

26.6 Central push handle with folding gripping area and folding push handle bar



Figure 191: Central push handle with folding gripping area



Figure 192: Foldable push handle bar

Adjusting the height of the central push handle and the push handle bar is possible without tools using quick release levers. To adjust, the quick release lever(s) is (are) opened and closed again after adjusting. The height can be infinitely adjusted.



Figure 193: Closed quick release lever



Figure 194: Quick release lever open

To **remove** the push handle, the M4 end stop screw (AF 3 mm) needs to be unscrewed and the quick release lever needs to be opened. On the push handle bar, both M4 end stop screws (AF 3 mm) must be unscrewed and both quick release levers opened.



Figure 195: M4 end stop screw attached to bottom of central push handle

If necessary the tension can be adjusted by turning the quick release lever clockwise until it reaches the end stop.

⚠ Prior to each use, the M4 end stop screws (AF 3 mm) must have been mounted again.

Angle adjustment or folding the gripping area is carried out via a serrated joint. To adjust the angle, the rotary knob is opened anti-clockwise and closed again by turning clockwise after setting the desired angle. On the push handle bar, both rotary knobs have to be operated.





Figure 196: Rotary knob for adjusting the angle and folding



Figure 197: Central push handle with folding gripping area completely folded

26.7 Safety instructions

 After every adjustment or after reattachment following removal, check that the push handles are firmly attached in position.

 Due to environmental effects, it is possible that the properties and therefore secure attachment of the push handle covers may change detrimentally. For this reason, it is important to check that the handles are tightly fitted and fixed in position prior to use. If this should no longer be the case, then the push handles may not be used until they have been fixed.

27 Passenger transport in motor vehicles

27.1 Standard specifications

In order to approve the product as a seat for passenger transport in motor vehicles, verification of the dynamic crash stability according to ISO 7176-19 (wheelchairs for use in motor vehicles) is required.

Furthermore, the additional retention system is required for the safe transport of the person sitting in the product in a motor vehicle, that complies with the requirements according to DIN 75078-2 (Motor vehicle for the transportation of handicapped persons – Part 2: Restraint systems; concepts, requirements, testing) and ISO 10542-2 (Technical systems and aids for

disabled or handicapped persons. Wheelchair tiedown and occupant-restraint systems).

PRO ACTIV offers passenger and wheelchair restraint systems with new orders, but also for retrofitting. In the following, we shall inform you about the use and application of this retention system when using the product as a seat in a motor vehicle.

27.2 Restraint systems

With the wheelchair restraint system, elements are designated that are used to secure the wheelchair in the vehicle. Persons are secured using components of the person retention system (PRS). A comprehensive system for the optimum transportation of the wheelchair in the motor vehicle comprises both components. These are matched to one-another so that their forces are not transferred to another system.

Similar to the crash test performed, a suitable wheelchair and passenger restraint system consists of a 4-point wheelchair restraint system and a 3-point passenger restraint system.

Elements of the **wheelchair restraint system** include:

- Retractors consisting of 2 retractors at the front without hand tensioning wheel and 2 retractors at the rear with hand tensioning wheel (e.g. manufacturer Schnierle Safety Belts GmbH).



Figure 198: Front retractor "semi-automatic" with buckle and belt link



Figure 199: Rear retractor "semi-automatic" with hand wheel, buckle and belt link

The **person restraint system** comprises:

- Lap belt with lock (e.g. manufacturer Schnierle Safety Belts GmbH).



Figure 200: Hip strap with lock, the fittings for connecting the transport restraints and two belt links for the selective securing of the diagonal shoulder belt

- Diagonal shoulder belt with lock head (e.g. manufacturer Schnierle Safety Belts GmbH).



Figure 201: Automatic diagonal shoulder belt with deflector and buckle

- Headrest with padding including sturdy bracket.
The use of a headrest is recommended, as it offers better protection during travel when used properly.

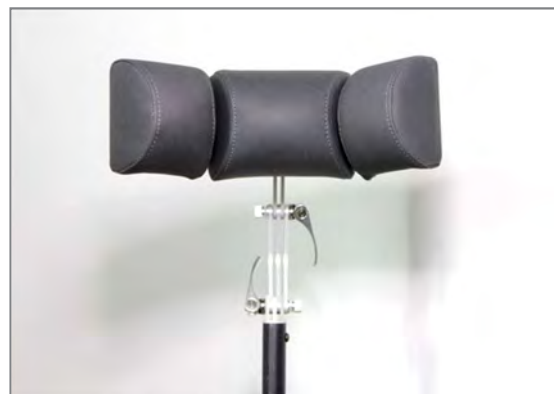

Figure 202: Headrest (example)

27.3 Marking

Wheelchairs tested according to ISO 7176-19 and approved for transporting passengers in motor vehicles are marked with the following karabiner symbol:



Figure 203: Karabiner symbol/sticker for a tested wheelchair approved for transporting passengers in motor vehicles

27.4 Fastening the wheelchair in the vehicle

Information about the fastening points for wheelchairs with and without transport restraint system is provided in the following.

Fastenings for wheelchairs **with transport restraint system**: the transport restraint system connections on the product (transport restraint system connection on the rear frame and bearing block intermediate plate) are marked with the above mentioned karabiner symbol.

- Transport restraint connection on the rear frame: The frame inlet can be used for installing the mount for the hip strap as well as for fixing the buckle that joins the rear retractor with the vehicle. As an alternative to the belt buckle, a transport restraint system connection with belt eye may also be attached.



Figure 204: Transport restraint system attachment on the rear frame with latch plates for rear retractor and lap belt (view from the side)



Figure 205: Transport restraint system attachment on the rear frame with latch plates for rear retractor and lap belt (view diagonally from the rear)



Figure 206: Transport restraint system attachment on the rear frame with belt eye for rear retractor and lap belt

- Bearing block intermediate plate with latch plate or belt eye for mounting the front retractor



Figure 207: Caster wheel bearing block intermediate plate with belt link for mounting the front retractor



Figure 208: Caster wheel bearing block intermediate plate with belt eye for front retractor

Fastenings for wheelchairs **without transport restraint system**: The fastening points for loops are marked with the above described karabiner symbol. The wheelchair restraint system fasteners must be fastened exclusively in the marked locations and must always be attached symmetrically on both sides of the wheelchair. The following figures show how the system is fastened on one side of the product.



Figure 209: Symbol for front fastening and wheelchair loop at the front (example for SPEEDY 4you Ergo)



Figure 210: Symbol for rear fastening and wheelchair loop at the rear (example for SPEEDY 4you Ergo)

27.5 Handling instructions and positioning the wheelchair in the vehicle

The crash test according to ISO 7176-19 demands a frontal impact at 48 kph and therefore represents only a part of the possible hazardous situations. Basically, all passengers must be seated on a standard vehicle seat with three-point seat belt. This is the safest possibility of transportation. If this cannot be implemented, the wheelchair as well as the passenger must be secured. The use of this retention system must be observed in the following guidelines and safety instructions.

 The wheelchair must only be transported in the direction of travel in the vehicle, as it was tested facing forwards in the direction of travel according to ISO 7176-19.

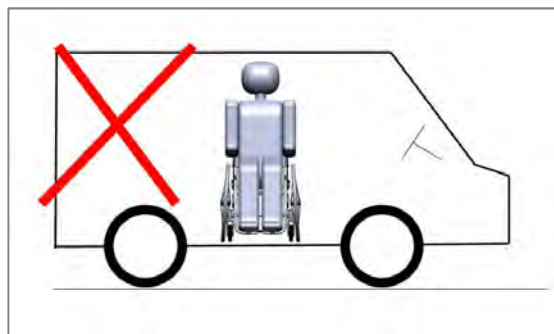

Figure 211: Incorrect positioning of the wheelchair in the vehicle

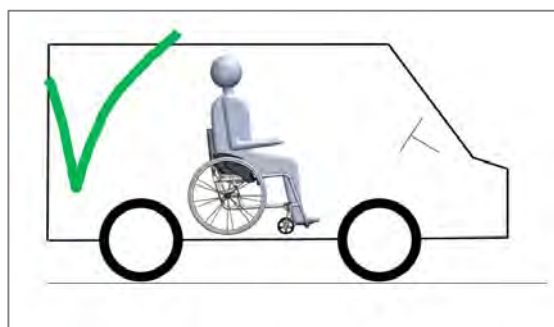

Figure 212: Correct positioning of the wheelchair in the vehicle

The two rear belts (retractors) must be arranged symmetrically and anchored at an angle of 30° to max. 45° from the horizontal on the vehicle floor. The two front belts must also be arranged symmetrically, and the angle from the horizontal must lie in the 40° to max. 60° range. The retractors for the front and rear must not be swapped.



Figure 213: Run of the retractors at the front and rear with maximum tensioning angle and connecting points (view from the side)

The two rear belts must each be fastened symmetrically at a max. angle of 10° outwards from the vertical.

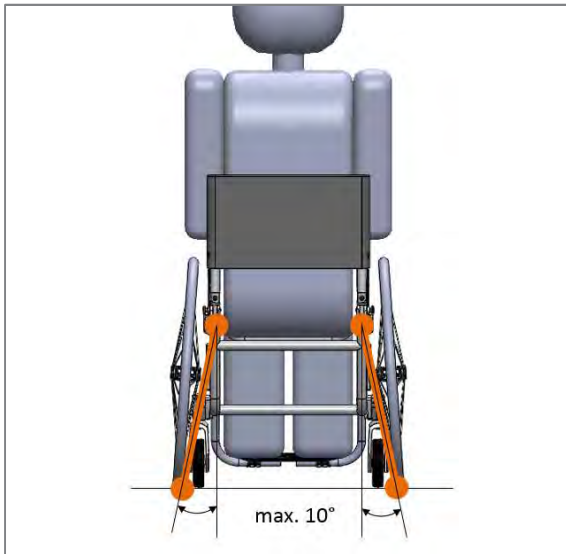

Figure 214: Run of the retractors at the rear with maximum tensioning angle and attaching points (view from the rear)

The two front belts must also each be fastened symmetrically at a max. angle of 25° outwards from the vertical.

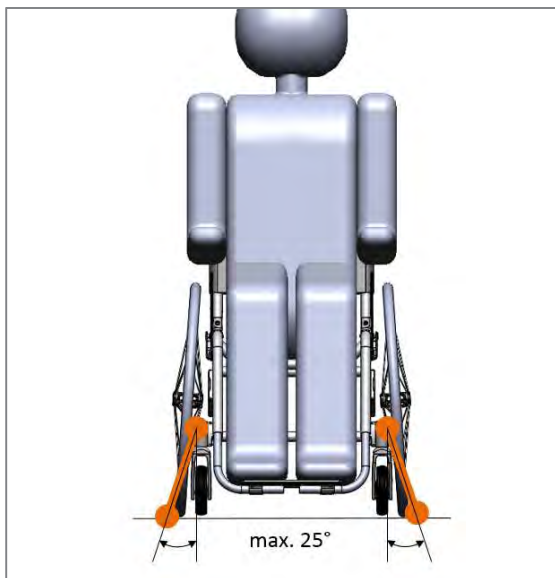

Figure 215: Run of the retractors at the front with maximum tensioning angle and attaching points (view from the front)

The user should be secured with both the lap belt and the diagonal shoulder belt in order to reduce the possibility of the head and chest impacting against vehicle components or other passengers and their wheelchairs.

The hip belt must rest tight against the body over the hip bone. It must be fastened so that, after closing, it runs at an angle of 30° to 75° from the horizontal when viewed from the side. A steeper angle is desirable (closer to 75°), but no higher under any circumstances. The belt must not be twisted and not run over the person's stomach.

The diagonal shoulder belt must run centrally over the collarbone (at an angle of max. 55° from the horizontal), must be a sufficient distance away from the neck and must lie tightly against the body.

The belts should lie as firmly as possible against the body without limiting the user's comfort. They may not be kept away from the body by parts of the wheelchair (armrests, side sections, clothing guard, etc.).

Recommendation:

The diagonal shoulder belt should be connected directly to the latch plate of the transport restraint system lap belt, not to the latch plate provided in the vehicle.

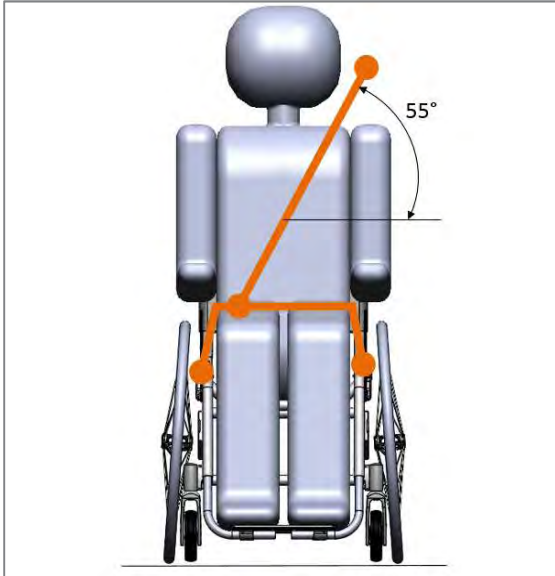

Figure 216: Run of the lap and diagonal shoulder belt with the respective connecting points (view from the front)

Adjustable-inclination backrests must be set to the most vertical position in order to ensure upright sitting.

The height and distance of the headrest to the head must be set so that the centre of gravity of the upright head is in the middle of the headrest and the distance between the head and headrest padding must be kept as little as possible (max. 2-3 cm).

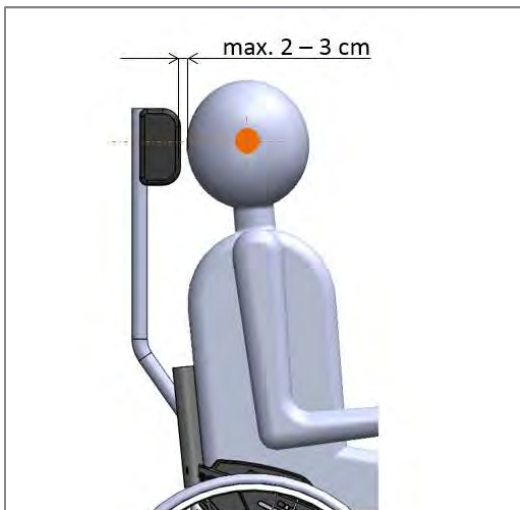



Figure 217: Setting a headrest with regard to the height and distance from the head

To ensure that the wheelchair user is adequately protected against collisions with vehicle parts and panels, the following clearances must be adhered to around him:

- To the front, at least 65 cm (95 cm for use of a lap belt without a diagonal shoulder belt) measured from the front edge of the head
- To the rear, at least 45 cm measured from the rear edge of the head
- Upwards, at least 120 cm for a small, female adult, or at least 155 cm for a large, male adult, each measured from the vehicle floor.

27.6 Safety instructions

 You must be able to hear all links engaging in the buckles. Belts must not be twisted and not run crossed-over.

 For belt systems (hip, diagonal shoulder belt, retractors), the instructions for use of the respective manufacturer must be observed.

 During transport, the parking brake of the product must be applied.

 Loose parts of the wheelchair (therapy tray, crutches, etc.) must be removed prior to the journey and stowed securely in the vehicle to prevent injuries to the vehicle occupants in the event of a collision.

 Wheelchairs and restraint systems that have been exposed to an impact must be replaced. They may no longer be used as a seat or for securing in motor vehicles.

28 Storage

When being stored, the product should be kept in a dry environment and covered up where possible.

To avoid corrosion and therefore malfunctions or breakages of components, the product may not be exposed to any aggressive environmental influences (especially salt) or to any strong solar radiation. Because of the effect of salt water in the winter and the humidity on rainy days, it is not recommended to store the product in the garage.

 If the product is not used or is stored over a longer period, if necessary, before using it again, we recommend having a rehabilitation specialist dealer give it a general function and safety check.

29 Transport

29.1 Securing handling of the product

When loading or transporting, the product can be held on the frame and on the back cross bar.

29.2 Passenger transport in motor vehicles

The transportation of persons in a wheelchair or other persons in the product in motor vehicles is only permitted when observing the equipment specified in Chapter 27. In this case, observe the versions in Chapter 27.

29.3 Securing the product in a vehicle (without a person)

To reduce weight, individual components such as the caster forks with caster wheels and the drive wheels can be removed from the product for loading and stored separately. The product and all associated components must be secured during transport so that they are not damaged (e.g., by falling over) and do not become a hazard to persons or other products. Before transport, check with your vehicle deal-

er about safely securing it using the existing fitted lashing rings or other securing devices. Suitable brackets are mostly available in the vehicle and are described in the operating manual of the vehicle.

When the product is in the transport vehicle, you or the person accompanying you should proceed as follows:

1. Operate the parking brake.
2. Secure and safely stow any components from the product which have been previously removed.
3. Bags, walking sticks, and other objects not belonging to the product which are on or in the product, must be removed and securely stowed.
4. Secure the product with lashing straps. To do this, use the existing securing devices in the vehicle. After securing, the product may not roll, slip or tip over to the side any more.

 The tensioning straps used to fasten the product securely in the transport vehicle must only be attached to the motor vehicle components intended for that purpose and to the frame of the product.

 Do not transport the product on the front passenger seat. The product could slip and impede the driver.

29.4 Passenger transport over obstacles in the product

 If the product with its user needs to be transported over an obstacle and there are suitable facilities such as a ramp or a lift available, then these should be used. If such facilities are not available, then the obstacle is to be overcome by being carried by two helpers. When carrying the product, it may not be lifted by the side sections, the drive wheels or the footrests. PROACTIV recommends holding the product by the frame and the back cross bar to carry it.

The procedure with stairs is usually as follows:

Climbing up stairs:

1. Two assistants carry the product with its user backwards up the stairs. The anti-tipping supports are in the passive position.
2. The assistant behind the product has the control. They tilt the product and have a firm grip on the back cross bar during the transport process.
3. The second helper at the front grips the product by the frame and lifts the product up one step at a time.
4. The helpers then move to the next step up and repeat the process until they reach the end.
5. The user can help the climb by rotating the handrim.

Climbing down stairs:

1. Two assistants carry the product with its user forwards down the stairs. The anti-tipping supports are in the passive position.
2. The assistant behind the product has the control. They tilt the product and have a firm grip on the back cross bar during the transport process.
3. The second assistant stands securely on a lower step and grips the product by the frame. They lift the product down one step by letting the drive wheels roll over the edge of the step.
4. The helpers then stand on the next step down and repeat the process until they reach the end.
5. The user can help the descent by breaking on the handrim.

30 Malfunctions

In the event of any malfunctions which cannot be repaired by yourself based on the usage instructions included in the scope of delivery, please contact your rehabilitation specialist dealer or PRO ACTIV directly.

 Malfunctions must be repaired before any further use or, if they occur during the trip, it must be interrupted immediately.

All serious incidents that have occurred in connection with the product must be reported to the manufacturer and the responsible authority in the state in which the user resides.

31 Cleaning and care

Regularly cleaning the product is prescribed to prevent the components from becoming stiff due to soiling. In particular, the product should be carefully cleaned after every major use, e.g. summer or winter holidays.

To avoid corrosion and therefore malfunctions or breakages of components, the product may not be exposed to any aggressive environmental influences. If this cannot be avoided, the product must always be cleaned immediately after such use, and moving parts must be greased. Regular cleaning prevents corrosion and increased wear.

In case the product becomes wet when using, dry it after use.

 Clean the quick release axles of the drive and caster wheels as well as the ball bearings and grease these with a little lubricating oil with high corrosion protection properties (e.g. Neoval MTO 300) approx. every 8 weeks in order to guarantee the reliable functioning properties.

 Clean your product with water, solvent or neutral cleaning agents. Do not use any abrasive cleaning agents or aggressive, acidic cleaners, to prevent scratching or fading of the coating or the anodised parts. Only use water and soap to clean the seat and backrest upholstery.

 The product must not be cleaned using steam or high pressure.

Recommended care:

If you need care products for your product, please contact PRO ACTIV.

32 Maintenance

32.1 General instructions

The product is not a maintenance-free device. Therefore, please observe the following instructions about maintenance.

 If repairs are required or there are any defects on your product, you should contact your rehabilitation specialist dealer or PRO ACTIV before using it again and have the defect remedied in the interests of your own safety. Screws and other elements need to be secured properly again after repairs.

 For tyres with tread: As soon as there is one or more points with less than 1 mm of tread on the tyres, the tyres must be changed as otherwise there is an increased risk of an accident.

 For tyres without tread: As soon as there is one or more points where the tyre carcass or the puncture-proofing is visible, the tyres must be changed as otherwise there is an increased risk of an accident.

 Only manufacturer's original parts may be used when ordering spare parts.

 Repairs and conversions to the product may only be carried out by your rehabilitation specialist dealer or PRO ACTIV.

Tightening torques and securing details for fastening elements as shown in the table in Chapter 37 must be observed.

32.2 Service schedules

There is some **maintenance work or checks which should be carried out by the user themselves** at regular intervals (approximately every 4 weeks depending on the frequency of use):

- Check the tyres for damage, foreign bodies and any cracks that form.
- Check the tyre pressure and correct if needed (the tyre pressure should always be as printed on the tyre covers).
- Check the brakes (function, wear on brake pins).
- Clean and oil the pivot points of the brakes and check the ease of movement or actuation force of the brake levers.
- Check the function of the anti-tipping device.
- Check the stable stand of the seat and backrest upholstery.
- Check the tight fit of the fixing screws on the seat and back system.
- Check the function and ease of running of the quick release axles of the drive wheels and caster forks.

 If you should discover any problems during these checks, please immediately contact your rehabilitation specialist dealer or PRO ACTIV. Service and repair work on the product may only be carried out by your rehabilitation specialist dealer or PRO ACTIV.

In addition to these maintenance tasks/checks by the user, PRO ACTIV has prescribed **maintenance tasks to be carried out by the rehabilitation specialist dealer or PRO ACTIV** for safe operation of the product and to minimise the risk to the user or third-parties.

The initial inspection is performed six weeks after delivery. The maintenance schedule can be found in the inspection lists in Chapter 40.

Subsequent inspections are then always performed a year after the last inspection. The maintenance schedule can be found in the inspection lists in Chapter 40.

After extreme stresses, such as during holidays where the product was exposed to sand, sea water or snow, an additional deep clean and inspection by your rehabilitation specialist dealer is recommended.

To maintain the warranty validity, the performance of the maintenance tasks must be documented. Any faults identified during maintenance work must be rectified and documented as such before further use of the product.

Even if your product does not show any signs of wear, damage or malfunctions, the regular safety-related checks on your product must be carried out in accordance with the maintenance schedule.

32.3 Proof of maintenance

To provide proof of the maintenance, you can use the inspection lists in Chapter 40. Always keep all receipts/service reports as proof, and have any service work that has not been carried out by the manufacturer documented.

Please bring these usage instructions/the service booklet along with you each time maintenance is performed.

33 Disposal & recycling

At the end of the service life, the product can be disposed of by PRO ACTIV or your rehabilitation specialist dealer in a proper, environmentally-friendly manner.

The disposal or recycling must be carried out by a waste disposal company or a municipal waste disposal centre.

Special guidelines may apply on-location with regard to the disposal or recycling. These must be clarified and considered when disposing (this may also include the cleaning or disinfection of the product before the disposal).

In the following text, you will find a description of the materials for the disposal and recycling of the product and its packaging:

Aluminium: Frame, rims, caster forks, brakes, back cross bar, side sections, clothing guard, armrest frame, footrest, footplate support, push handles

Steel: Fastening points, quick-release/screwed axles, push handles, anti-tipping supports, brakes, armrest frame, screws, nuts

Plastic: Handles, quick release levers, tube plugs, caster wheels, armrest padding, tyres, footplate, side sections, brake lever, anti-tipping wheels, bags for packing

Synthetic fibres and foam: padding, covers

Cardboard/paper: Packaging

34 Re-use

If your product has been provided to you by your funding provider and you no longer require it, you should report this fact to your health insurance company or your rehabilitation specialist dealer. Your product can then be simply and economically re-used.

Prior to each re-use, a technical safety check must be carried out on the product at PRO ACTIV or the rehabilitation specialist dealer. In addition to the instructions contained in Chapter 31 (Cleaning and care), a thorough cleaning of all control elements must be carried out before using it again.

Before the product can be reused, it must be prepared with care. A disinfection agent that is suitable for medical products must be sprayed onto all surfaces that the user may come into contact with. A liquid, alcohol-based disinfectant for residue-free, quick disinfection (e.g. Exporit 4712) must be used for this, and the respective instructions for use of the disinfectant must be observed. In general, a complete disinfection cannot be guaranteed on the seams. We therefore recommend that you dispose of the seat and backrest upholstery.

These preparations will be performed by PRO ACTIV or the rehabilitation specialist dealer as part of the technical safety check. This safety-related check **must** be initiated by the funding provider.

Moreover, in event of wear or due to adaptation to the new user, components such as the footrest, seat and back system can be adjusted or replaced using the modular system. In addition, the backrest angle is usually adjustable in seven stages, therefore enabling optimum adaptation.

35 Warranty

PRO ACTIV guarantees that the product was free of any defects at the time it was handed over. This warranty expires 24 months after the product was delivered.

Further information can be found in PRO ACTIV's general terms and conditions at www.proactiv-gmbh.com.

The warranty shall be null and void if the product or a part needs to be repaired or replaced due to the following reasons:

- Normal wear on components such as tyres of caster wheels & drive wheels, anti-tipping wheels, handles, brake pins, upholstery of seat and back systems, etc.
- The product has not been maintained and serviced in accordance with the maintenance schedule laid down by PRO ACTIV.
- The product or a part of the product has been damaged due to neglect, accident, or improper use.
- The product has been commissioned and used in non-compliance with these usage instructions.
- Repairs or other work have been carried out by non-authorized persons.
- Third-party parts have been installed or connected to the product or the product was otherwise modified.

 Product modifications that have not been expressly approved by PRO ACTIV will invalidate the warranty. Such modifications can lead to unforeseeable safety risks and are therefore not permitted.

36 Liability

As the manufacturer of the product, PRO ACTIV is not responsible for its safety if:

- The product is handled improperly.
- The product is not maintained in accordance with the maintenance schedule laid down by PRO ACTIV.
- The product is commissioned and used in non-compliance with these usage instructions.
- Repairs or other work are carried out by non-authorized persons.
- Third-party parts have been installed or connected to the product or the product has otherwise been modified.

Further information can be found in PRO ACTIV's general terms and conditions at www.proactiv-gmbh.com.

37 Appendix: Tightening torques, securing details and tools

The following table shows the torques for shaft screws with a metric control thread (valid providing the drawing, assembly, or usage instructions do not state different values!):

Dimension	Tightening torque Ma in Nm depending on the screw strength	
	Strength 8.8 (e.g. cylinder head screw)	Strength 10.9 (e.g. oval head screw)
M4	2.1	3.1
M5	4.2	6.1
M6	7.3	11
M8	17	26
M10	34	51
M12	59	87
M10 x 1	36	53

Securing details: All screws on PRO ACTIV products must be secured with "medium strength" screw locking fluid (e.g. Weicon AN302-43) provided that no securing clamps are present on the screw connections or a lubrication instruction specifies the use of grease or copper paste.

In the following table you will find tools and care products for your PRO ACTIV product:

Tool	Order number
Adjustment bracket for the caster wheel bearing block	8000 901 000
Special tool for setting the wheel position Open-ended spanner AF 22/24 mm + 41 mm	8000 900 025
Tool set for PRO ACTIV wheelchairs Mini high-pressure pump, open-ended spanner AF 8/10 + 10/13 30 mm, Allen key AF 2.5 + 6 mm, hexagon socket screwdriver with handle AF 3 + 4 + 5 mm	8000 900 030
Care kit for PRO ACTIV wheelchairs and handbikes Assembly paste (dosing syringe 10 g), Neoval oil (spray 100 ml), screw locking fluid, medium strength (pen system 10 ml), surface cleaner (spray 150 ml), terminal grease (tube 50 ml)	8000 900 026
Assembly stands 	8000 902 000

38 Appendix: Medical product passport/record of training

Product specifications:

Serial number: _____

Customer data:

Surname, forename: _____

Street: _____

Postcode, city: _____

Phone: _____

Paying organisation: _____

Training carried out by:

Rehabilitation specialist
dealer

PRO ACTIV Field
Representative/
Product adviser

Stamp / Date / Rehabilitation specialist dealer's signature

Record of training

I was/we were instructed in accordance with the associated hand-over certificate about the operation of the product listed and informed about possible operator errors. I was/we were also advised about situations where the assistance of another person is required. The usage instructions were handed to me/us.

Instructor

Name, date, signature _____

1. Person being trained

Name, date, signature _____

2. Person being trained

Name, date, signature _____

3. Person being trained

Name, date, signature _____

For minors, or persons who are not responsible for their actions, legal guardians/supervisors/responsible persons are to be trained in the use. This is confirmed by their signature. The data are recorded in the feedback system of PRO ACTIV Reha-Technik GmbH as the manufacturer of the above named product. It is managed in accordance with § 16 BDSG (German Data Protection Law).

39 Appendix: Hand-over certificate

39.1 Required compliance criteria to authorise use

Topics	Completed/fulfilled	Remarks
The product is suitable for the customer based on their own judgement and the customer information received regarding the disability-related restrictions.		
The use intended by the customer is fully consistent with the intended use as described in the usage instructions (see Chapter "Purpose and indication").		
The product's equipment is suitable to allow the customer safe use with maximum reduction of risks.		
The customer's driving ability was checked during a test drive in difficult driving situations and found to be appropriate (see the check list on the following page).		
The usage instructions - and explicitly all of the warning and safety instructions contained therein - were discussed during the training in detail and understood by the user. The user was then handed these operating instructions.		

39.2 Check list for training the user

Topics	Completed/fulfilled
All mechanical function control elements were explained and their function demonstrated.	
Use of the brakes was demonstrated and then performed by the user themselves and/or their assistant.	
Attention was drawn to the fact that it is a parking brake and not a service brake (except for drum brakes).	
Backrest angle adjustment and other backrest adjustment options were demonstrated and then tested by the user themselves and/or their assistant.	
The possible adjustments of the seating system were demonstrated and then tested by the user themselves and/or their assistant.	
Fitting and removing the clothing guard was demonstrated and then tested by the user themselves and/or their assistant.	
How the push handles are used and adjusted was demonstrated and then tested by the user themselves and/or their assistant.	
How the footrests work was demonstrated and then tested by the user themselves and/or their assistant.	
Use of the anti-tipping supports was demonstrated and then performed by the user themselves and/or their assistant.	
Removal and installation of the drive wheels and the caster forks (with quick-release axles) was demonstrated and then tested by the user themselves and/or their assistant.	
Adaptation of the wheelbase extension on the product – if available – was demonstrated and then performed by the user themselves and/or their assistant.	
Repositioning the drive wheels from the standard position to the wheelbase extension sockets – if available – was demonstrated and then performed by the user themselves and/or their assistant.	
Test drive: Overcoming obstacles with the product, e.g. a kerb	
Test drive: Driving forwards and backwards on level ground and also up and down hills in the direction of travel, including slaloming around some obstacles	
Test: Operating the anti-tipping supports in front of an obstacle	
Information for care, cleaning and maintenance of the product (including quick release axles) have been provided and understood by the user and/or assistant.	
Information on the wheels with regard to inflation pressure and tread depth and checking the quick release axles have been provided and understood by the user and/or assistant.	
Information on regular checks of the brakes, anti-tipping supports and the seating and back system have been provided and understood by the user and/or assistant.	
The content of the usage instructions from PRO ACTIV and the other component manufacturers (if available) were completely worked through based on the product training and were understood by the user and/or the assistant.	

The use of the product is only permitted when all topics listed in "Required compliance criteria for those permitted to use" have been met by the user and all the points have been ticked off in the "Check list for training the user".

40 Appendix: Inspection lists

Initial inspection: after 6 weeks

Serial number: SN _____	OK/ carried out	not OK	resolved
Check that all screws/fastening elements are firmly seated	<input type="checkbox"/>	<input type="checkbox"/>	<input type="checkbox"/>
Check wheel tracking and drive wheel bushing are firmly seated (tightening torque 70 Nm)	<input type="checkbox"/>	<input type="checkbox"/>	<input type="checkbox"/>
Check the correct adjustment of the caster fork rotary axle	<input type="checkbox"/>	<input type="checkbox"/>	<input type="checkbox"/>
Function and safety check of the brakes, push handles and anti-tipping supports as well as further functional components (such as, e.g. folding backrest, fold-up footrest)	<input type="checkbox"/>	<input type="checkbox"/>	<input type="checkbox"/>

OK / carried out = OK | not OK = not OK | resolved = the fault was corrected

Comments:

Rehabilitation specialist dealer:

First name and last name of contact:

Stamp:

Date/signature

To maintain the warranty rights, the completed inspection list must be sent by e-mail or post to PRO ACTIV within four weeks of the inspection.

Subsequent inspection: One year later after the last inspection or earlier following particular loading

Serial number: SN _____	OK / carried out	not OK	resolved
Check that all screws/fastening elements are firmly seated	<input type="checkbox"/>	<input type="checkbox"/>	<input type="checkbox"/>
Clean and oil/grease all pivot points, quick release axles and bearings	<input type="checkbox"/>	<input type="checkbox"/>	<input type="checkbox"/>
Visual inspection of the frame and attachments for crack formation, deformation, etc.	<input type="checkbox"/>	<input type="checkbox"/>	<input type="checkbox"/>
Functional/safety check of push handles	<input type="checkbox"/>	<input type="checkbox"/>	<input type="checkbox"/>
Functional/safety check of braking system	<input type="checkbox"/>	<input type="checkbox"/>	<input type="checkbox"/>
Functional/safety check of anti-tipping supports	<input type="checkbox"/>	<input type="checkbox"/>	<input type="checkbox"/>
Functional/safety check of the seat and back system	<input type="checkbox"/>	<input type="checkbox"/>	<input type="checkbox"/>
Carry out a functional/safety check of the drive wheels and, if required, replace the tyres on the product	<input type="checkbox"/>	<input type="checkbox"/>	<input type="checkbox"/>
Check wheel tracking and drive wheel bushing are firmly seated (tightening torque 70 Nm)	<input type="checkbox"/>	<input type="checkbox"/>	<input type="checkbox"/>
Functional/safety check of caster wheels	<input type="checkbox"/>	<input type="checkbox"/>	<input type="checkbox"/>
Check the caster wheel axle for firm seating (tightening torque 7 Nm) and correct adjustment of the caster fork axle	<input type="checkbox"/>	<input type="checkbox"/>	<input type="checkbox"/>
Functional/safety check of footrests	<input type="checkbox"/>	<input type="checkbox"/>	<input type="checkbox"/>
Test drive/functional test	<input type="checkbox"/>	<input type="checkbox"/>	<input type="checkbox"/>

OK / carried out = OK | not OK = not OK | resolved = the fault was corrected

Comments:

Rehabilitation specialist dealer:

First name and last name of contact:

Stamp:

Date/signature

To maintain the warranty rights, the completed inspection list must be sent by e-mail or post to PRO ACTIV within four weeks of the inspection.

Subsequent inspection: One year later after the last inspection or earlier following particular loading

Serial number: SN _____	OK / carried out	not OK	resolved
Check that all screws/fastening elements are firmly seated	<input type="checkbox"/>	<input type="checkbox"/>	<input type="checkbox"/>
Clean and oil/grease all pivot points, quick release axles and bearings	<input type="checkbox"/>	<input type="checkbox"/>	<input type="checkbox"/>
Visual inspection of the frame and attachments for crack formation, deformation, etc.	<input type="checkbox"/>	<input type="checkbox"/>	<input type="checkbox"/>
Functional/safety check of push handles	<input type="checkbox"/>	<input type="checkbox"/>	<input type="checkbox"/>
Functional/safety check of braking system	<input type="checkbox"/>	<input type="checkbox"/>	<input type="checkbox"/>
Functional/safety check of anti-tipping supports	<input type="checkbox"/>	<input type="checkbox"/>	<input type="checkbox"/>
Functional/safety check of the seat and back system	<input type="checkbox"/>	<input type="checkbox"/>	<input type="checkbox"/>
Carry out a functional/safety check of the drive wheels and, if required, replace the tyres on the product	<input type="checkbox"/>	<input type="checkbox"/>	<input type="checkbox"/>
Check wheel tracking and drive wheel bushing are firmly seated (tightening torque 70 Nm)	<input type="checkbox"/>	<input type="checkbox"/>	<input type="checkbox"/>
Functional/safety check of caster wheels	<input type="checkbox"/>	<input type="checkbox"/>	<input type="checkbox"/>
Check the caster wheel axle for firm seating (tightening torque 7 Nm) and correct adjustment of the caster fork axle	<input type="checkbox"/>	<input type="checkbox"/>	<input type="checkbox"/>
Functional/safety check of footrests	<input type="checkbox"/>	<input type="checkbox"/>	<input type="checkbox"/>
Test drive/functional test	<input type="checkbox"/>	<input type="checkbox"/>	<input type="checkbox"/>

OK / carried out = OK | not OK = not OK | resolved = the fault was corrected

Comments:

Rehabilitation specialist dealer:

First name and last name of contact:

Stamp:

Date/signature

To maintain the warranty rights, the completed inspection list must be sent by e-mail or post to PROACTIV within four weeks of the inspection.

Subsequent inspection: One year later after the last inspection or earlier following particular loading

Serial number: SN _____	OK / carried out	not OK	resolved
Check that all screws/fastening elements are firmly seated	<input type="checkbox"/>	<input type="checkbox"/>	<input type="checkbox"/>
Clean and oil/grease all pivot points, quick release axles and bearings	<input type="checkbox"/>	<input type="checkbox"/>	<input type="checkbox"/>
Visual inspection of the frame and attachments for crack formation, deformation, etc.	<input type="checkbox"/>	<input type="checkbox"/>	<input type="checkbox"/>
Functional/safety check of push handles	<input type="checkbox"/>	<input type="checkbox"/>	<input type="checkbox"/>
Functional/safety check of braking system	<input type="checkbox"/>	<input type="checkbox"/>	<input type="checkbox"/>
Functional/safety check of anti-tipping supports	<input type="checkbox"/>	<input type="checkbox"/>	<input type="checkbox"/>
Functional/safety check of the seat and back system	<input type="checkbox"/>	<input type="checkbox"/>	<input type="checkbox"/>
Carry out a functional/safety check of the drive wheels and, if required, replace the tyres on the product	<input type="checkbox"/>	<input type="checkbox"/>	<input type="checkbox"/>
Check wheel tracking and drive wheel bushing are firmly seated (tightening torque 70 Nm)	<input type="checkbox"/>	<input type="checkbox"/>	<input type="checkbox"/>
Functional/safety check of caster wheels	<input type="checkbox"/>	<input type="checkbox"/>	<input type="checkbox"/>
Check the caster wheel axle for firm seating (tightening torque 7 Nm) and correct adjustment of the caster fork axle	<input type="checkbox"/>	<input type="checkbox"/>	<input type="checkbox"/>
Functional/safety check of footrests	<input type="checkbox"/>	<input type="checkbox"/>	<input type="checkbox"/>
Test drive/functional test	<input type="checkbox"/>	<input type="checkbox"/>	<input type="checkbox"/>

OK / carried out = OK | not OK = not OK | resolved = the fault was corrected

Comments:

Rehabilitation specialist dealer:

First name and last name of contact:

Stamp:

Date/signature

To maintain the warranty rights, the completed inspection list must be sent by e-mail or post to PRO ACTIV within four weeks of the inspection.

Subsequent inspection: One year later after the last inspection or earlier following particular loading

Serial number: SN _____	OK / carried out	not OK	resolved
Check that all screws/fastening elements are firmly seated	<input type="checkbox"/>	<input type="checkbox"/>	<input type="checkbox"/>
Clean and oil/grease all pivot points, quick release axles and bearings	<input type="checkbox"/>	<input type="checkbox"/>	<input type="checkbox"/>
Visual inspection of the frame and attachments for crack formation, deformation, etc.	<input type="checkbox"/>	<input type="checkbox"/>	<input type="checkbox"/>
Functional/safety check of push handles	<input type="checkbox"/>	<input type="checkbox"/>	<input type="checkbox"/>
Functional/safety check of braking system	<input type="checkbox"/>	<input type="checkbox"/>	<input type="checkbox"/>
Functional/safety check of anti-tipping supports	<input type="checkbox"/>	<input type="checkbox"/>	<input type="checkbox"/>
Functional/safety check of the seat and back system	<input type="checkbox"/>	<input type="checkbox"/>	<input type="checkbox"/>
Carry out a functional/safety check of the drive wheels and, if required, replace the tyres on the product	<input type="checkbox"/>	<input type="checkbox"/>	<input type="checkbox"/>
Check wheel tracking and drive wheel bushing are firmly seated (tightening torque 70 Nm)	<input type="checkbox"/>	<input type="checkbox"/>	<input type="checkbox"/>
Functional/safety check of caster wheels	<input type="checkbox"/>	<input type="checkbox"/>	<input type="checkbox"/>
Check the caster wheel axle for firm seating (tightening torque 7 Nm) and correct adjustment of the caster fork axle	<input type="checkbox"/>	<input type="checkbox"/>	<input type="checkbox"/>
Functional/safety check of footrests	<input type="checkbox"/>	<input type="checkbox"/>	<input type="checkbox"/>
Test drive/functional test	<input type="checkbox"/>	<input type="checkbox"/>	<input type="checkbox"/>

OK / carried out = OK | not OK = not OK | resolved = the fault was corrected

Comments:

Rehabilitation specialist dealer:

First name and last name of contact:

Stamp:

Date/signature

To maintain the warranty rights, the completed inspection list must be sent by e-mail or post to PROACTIV within four weeks of the inspection.

Subsequent inspection: One year later after the last inspection or earlier following particular loading

Serial number: SN _____	OK / carried out	not OK	resolved
Check that all screws/fastening elements are firmly seated	<input type="checkbox"/>	<input type="checkbox"/>	<input type="checkbox"/>
Clean and oil/grease all pivot points, quick release axles and bearings	<input type="checkbox"/>	<input type="checkbox"/>	<input type="checkbox"/>
Visual inspection of the frame and attachments for crack formation, deformation, etc.	<input type="checkbox"/>	<input type="checkbox"/>	<input type="checkbox"/>
Functional/safety check of push handles	<input type="checkbox"/>	<input type="checkbox"/>	<input type="checkbox"/>
Functional/safety check of braking system	<input type="checkbox"/>	<input type="checkbox"/>	<input type="checkbox"/>
Functional/safety check of anti-tipping supports	<input type="checkbox"/>	<input type="checkbox"/>	<input type="checkbox"/>
Functional/safety check of the seat and back system	<input type="checkbox"/>	<input type="checkbox"/>	<input type="checkbox"/>
Carry out a functional/safety check of the drive wheels and, if required, replace the tyres on the product	<input type="checkbox"/>	<input type="checkbox"/>	<input type="checkbox"/>
Check wheel tracking and drive wheel bushing are firmly seated (tightening torque 70 Nm)	<input type="checkbox"/>	<input type="checkbox"/>	<input type="checkbox"/>
Functional/safety check of caster wheels	<input type="checkbox"/>	<input type="checkbox"/>	<input type="checkbox"/>
Check the caster wheel axle for firm seating (tightening torque 7 Nm) and correct adjustment of the caster fork axle	<input type="checkbox"/>	<input type="checkbox"/>	<input type="checkbox"/>
Functional/safety check of footrests	<input type="checkbox"/>	<input type="checkbox"/>	<input type="checkbox"/>
Test drive/functional test	<input type="checkbox"/>	<input type="checkbox"/>	<input type="checkbox"/>

OK / carried out = OK | not OK = not OK | resolved = the fault was corrected

Comments:

Rehabilitation specialist dealer:

First name and last name of contact:

Stamp:

Date/signature

To maintain the warranty rights, the completed inspection list must be sent by e-mail or post to PRO ACTIV within four weeks of the inspection.

Subsequent inspection: One year later after the last inspection or earlier following particular loading

Serial number: SN _____	OK / carried out	not OK	resolved
Check that all screws/fastening elements are firmly seated	<input type="checkbox"/>	<input type="checkbox"/>	<input type="checkbox"/>
Clean and oil/grease all pivot points, quick release axles and bearings	<input type="checkbox"/>	<input type="checkbox"/>	<input type="checkbox"/>
Visual inspection of the frame and attachments for crack formation, deformation, etc.	<input type="checkbox"/>	<input type="checkbox"/>	<input type="checkbox"/>
Functional/safety check of push handles	<input type="checkbox"/>	<input type="checkbox"/>	<input type="checkbox"/>
Functional/safety check of braking system	<input type="checkbox"/>	<input type="checkbox"/>	<input type="checkbox"/>
Functional/safety check of anti-tipping supports	<input type="checkbox"/>	<input type="checkbox"/>	<input type="checkbox"/>
Functional/safety check of the seat and back system	<input type="checkbox"/>	<input type="checkbox"/>	<input type="checkbox"/>
Carry out a functional/safety check of the drive wheels and, if required, replace the tyres on the product	<input type="checkbox"/>	<input type="checkbox"/>	<input type="checkbox"/>
Check wheel tracking and drive wheel bushing are firmly seated (tightening torque 70 Nm)	<input type="checkbox"/>	<input type="checkbox"/>	<input type="checkbox"/>
Functional/safety check of caster wheels	<input type="checkbox"/>	<input type="checkbox"/>	<input type="checkbox"/>
Check the caster wheel axle for firm seating (tightening torque 7 Nm) and correct adjustment of the caster fork axle	<input type="checkbox"/>	<input type="checkbox"/>	<input type="checkbox"/>
Functional/safety check of footrests	<input type="checkbox"/>	<input type="checkbox"/>	<input type="checkbox"/>
Test drive/functional test	<input type="checkbox"/>	<input type="checkbox"/>	<input type="checkbox"/>

OK / carried out = OK | not OK = not OK | resolved = the fault was corrected

Comments:

Rehabilitation specialist dealer:

First name and last name of contact:

Stamp:

Date/signature

To maintain the warranty rights, the completed inspection list must be sent by e-mail or post to PROACTIV within four weeks of the inspection.

Subsequent inspection: One year later after the last inspection or earlier following particular loading

Serial number: SN _____	OK / carried out	not OK	resolved
Check that all screws/fastening elements are firmly seated	<input type="checkbox"/>	<input type="checkbox"/>	<input type="checkbox"/>
Clean and oil/grease all pivot points, quick release axles and bearings	<input type="checkbox"/>	<input type="checkbox"/>	<input type="checkbox"/>
Visual inspection of the frame and attachments for crack formation, deformation, etc.	<input type="checkbox"/>	<input type="checkbox"/>	<input type="checkbox"/>
Functional/safety check of push handles	<input type="checkbox"/>	<input type="checkbox"/>	<input type="checkbox"/>
Functional/safety check of braking system	<input type="checkbox"/>	<input type="checkbox"/>	<input type="checkbox"/>
Functional/safety check of anti-tipping supports	<input type="checkbox"/>	<input type="checkbox"/>	<input type="checkbox"/>
Functional/safety check of the seat and back system	<input type="checkbox"/>	<input type="checkbox"/>	<input type="checkbox"/>
Carry out a functional/safety check of the drive wheels and, if required, replace the tyres on the product	<input type="checkbox"/>	<input type="checkbox"/>	<input type="checkbox"/>
Check wheel tracking and drive wheel bushing are firmly seated (tightening torque 70 Nm)	<input type="checkbox"/>	<input type="checkbox"/>	<input type="checkbox"/>
Functional/safety check of caster wheels	<input type="checkbox"/>	<input type="checkbox"/>	<input type="checkbox"/>
Check the caster wheel axle for firm seating (tightening torque 7 Nm) and correct adjustment of the caster fork axle	<input type="checkbox"/>	<input type="checkbox"/>	<input type="checkbox"/>
Functional/safety check of footrests	<input type="checkbox"/>	<input type="checkbox"/>	<input type="checkbox"/>
Test drive/functional test	<input type="checkbox"/>	<input type="checkbox"/>	<input type="checkbox"/>

OK / carried out = OK | not OK = not OK | resolved = the fault was corrected

Comments:

Rehabilitation specialist dealer:

First name and last name of contact:

Stamp:

Date/signature

To maintain the warranty rights, the completed inspection list must be sent by e-mail or post to PRO ACTIV within four weeks of the inspection.

Your rehabilitation specialist dealer:

PRO  **ACTIV**®



PRO ACTIV Reha-Technik GmbH

Im Hofstätt 11

D-72359 Dotternhausen – Germany

Phone +49 7427 9480-0

Fax +49 7427 9480-7025

Email: info@proactiv-gmbh.de

www.proactiv-gmbh.com